

SEATING

PRICE LIST



2019
March

TABLE OF CONTENTS

CHAIR USES MATRIX	2
N-TUNE SEATING SYSTEM	4
GUARDIAN	5
CONNEXION ARM	5
SELLING POLICY	6
Terms & Conditions	6
Ordering	6
Prices	6
Taxes	6
Lead Time	6
Customer's Own Material	6
Storage Fee	6
Shipping	7
Freight Damage	7
Returns	7
Warranty Claims	7
Delay/Force Majeure	7
Compliance with Law	7
QUICK SHIP PROGRAM	8
Overview	8
Fabrics	8
WARRANTY	9
Lifetime Single Shift	9
Continuous-shift Intensive Use	9
GENERAL INFORMATION	10
Patent Information	10
Certification	10
Design	10
Women's Business Enterprise (WBE)	10
Woman Owned Small Business (WOSB)	10
Historically Underutilized Business (HUB)	10
BIFMA	10
SCS Indoor Advantage	10
Custom Logos	10
Cleanroom to Class 100	10
Commitment to Non-obsolescence	10
CAL133	11
ESD Seating	11
ESD Order Form	12
COM Form	13
GSA Contract Overview	14
GSA Contract Details	15
HIGH PERFORMANCE SEATING	16
Headrest Options	18
Back Options	18
Seat Options	18
Mechanism Options	19
Arm Options	19
1000 Series	20
5000 Series	22
6000 Series	24
8000 Series	26
8000 Series – Tall & Skinny	28
Big & Tall	30
XSM – Extra Small	32

TASK/CONFERENCE SEATING	34
Arm Options	36
Chair Mechanism Options	38
Stool Mechanism Options	39
Headrest Options	40
Connexion Arm	41
Balance	42
Cozi	44
Cozi Stool	46
Cozi 24/7	48
Cozi Guest	50
E-Series	52
Embrace	54
Embrace Guest	56
Icon	58
Knomi	60
Knomi Mesh/Mesh	62
NV	64
Renati	66
Right Chair	68
Right Chair Stool	70
Right Chair Mesh	72
Right Chair Mesh Stool	74
Right Chair Guest	76
U4ia	78
U4ia Stool	80
U4ia Guest	82
Ulius	84
Ulius Stool	86
Ulius Guest	88

ACTIVE/GUEST SEATING	90
Dice	92
Facet	94

INDUSTRIAL/HEALTHCARE SEATING	96
AbChair	98
Adapta Stool	100
Geo	102
Graphite	104
Stratus Upholstered	106
Stratus Urethane	108

STOOL OPTIONS	110
NeXtep	110
N-position	110
Footrings	111
Footrests	111

















WORKPLACE ACCESSORIES	112
Keyboard Arms	114
Keyboard Trays	114
Ascension Arm	115
Easy Combos	115
Forearm Supports	117
Anti-fatigue Floor Mats	117
CPU Holders	117
Adjustable Height Tables	117

SIT/STAND	118
StandUp	118
StandUp A1	118
StandUp X1	119

UPHOLSTERY	120
Fabrics	120
CAL133	120
ESD	120
Leathers	121
Quick Ship	121



















GRADED IN FABRICS	122
Arc Com	122
Carnegie	123
C.F. Stinson	124
C.F. Stinson Vinyl	125
DesignTex	126
Guilford of Maine	127
Knoll	128
Luna	128
Luum	129
Maharam	129
Mayer	130
Momentum	132
Paul Brayton	133
Ultrafabrics®	133
CTL Leather	133

Chair Uses Matrix

			Quick Ship	High Performance	Work/Task	Executive	Conference/ Training Room	Guest	Stools
		1000 Series page 20	QS	✓	✓	✓			✓
		5000 Series page 22	QS	✓	✓				✓
		6000 Series page 24	QS	✓	✓	✓			
		8000 Series page 26	QS	✓	✓	✓			✓
		Balance™ page 42			✓	✓	✓		
		Big & Tall page 30	QS	✓	✓	✓			
			QS		✓		✓	✓	✓
			QS		✓		✓	✓	✓
		Dice™ page 92						✓	
		E-Series™ page 52	QS		✓	✓	✓		✓

✓ Standard

Chair Uses Matrix

High Performance	Work/Task	Executive	Conference/ Training Room	Guest	Stools	Quick Ship				
		✓	✓	✓			Embrace™ page 54			
				✓		QS	Facet page 94			
	✓	✓	✓		✓	QS	Icon™ page 58			
	✓	✓	✓			QS	Knomi® page 60			
		✓	✓				NV™ page 64			
	✓	✓	✓		✓	QS	Renati™ page 66			
	✓	✓	✓	✓	✓	QS	Right Chair® page 68			
	✓	✓	✓	✓	✓	QS	U4ia® page 78			
	✓	✓	✓	✓	✓	QS	Ulius® page 84			
✓	✓	✓			✓	QS	XSM™ page 32			

✓ Standard

START OF A REVOLUTION

N·tune®, developed by Certified Professional Ergonomists, is all about raising desk heights from 29" to 40" and then raising the chair to stool height, allowing users to easily transition between sitting and standing throughout the workday. Not only does this help alleviate the pains of a sedentary workday, the overall health benefits it provides are immense as well.

By standing for just 2 hours more than normal throughout an average workday, you can burn an extra 280 calories, translating into improvements in BMI, cholesterol, blood pressure levels and many other positive health outcomes.

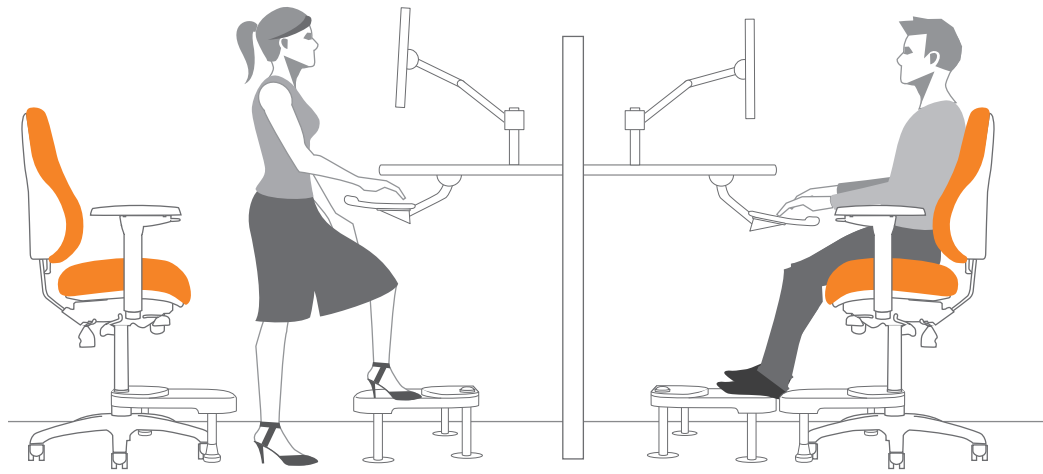

GOOD

- U4ia® with up to 13 adjustable features
- Single platform, depth adjustable 10" NeXtep®
- N-position™ with 10" platform
- N-position™ supports up to 400 lbs

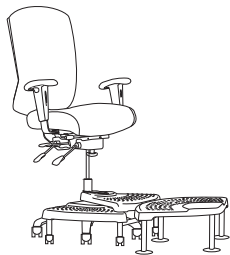

BETTER

- Cozi® with up to 13 adjustable features
- Dual platform, depth adjustable 8"/10" NeXtep® combo
- N-position™ with 10" platform
- N-position™ supports up to 400 lbs

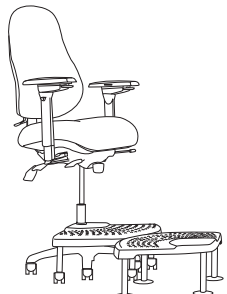

BEST

- 8000 Series with up to 15 adjustable features
- Wide single platform 10" NeXtep® provides more surface area
- N-position™ with 10" platform
- N-position™ supports up to 400 lbs

BULLET RESISTANT

The Guardian® is a NIJ Level II compliant bullet resistant vest custom fitted over the chair's back. A NIJ Level II compliant bullet resistant vest will provide protection against regular powered 9mm handguns, up to .357 Magnums. The vest fits over the back of the Cozi chair

and is easily removable. With the vest on the chair, it can also be used as a shield by kneeling behind the back of the chair. In a situation where response time can save your life, there is no quicker solution to protection than having the Guardian® at your desk.

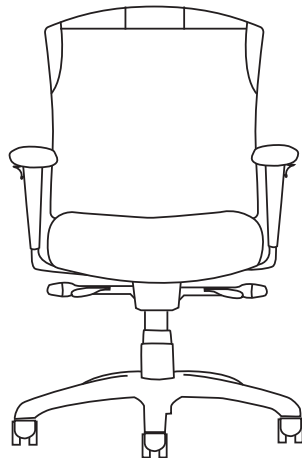

NIJ Level II compliant



Best of NeoCon gold award winner



Protection against regular powered 9mm handguns, up to .357 Magnums



Inconspicuous— looks like a regular chair



Use as shield or vest



AVAILABLE MODELS

Cozi	page 44
Cozi Stool	page 46
Cozi 24/7	page 48

CONNEXION® ARM

FEATURES

- Quickly and easily position your tablet where it's comfortable for you
- Holds your tablet so you don't have to
- Eliminates awkward postures and helps reduce upper body fatigue
- Engineered for ease of use
- Can be used while sitting or standing
- 3 mounting options, left, right or both

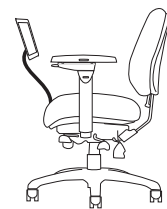

TERMS AND CONDITIONS

For all non-rated or new accounts, payment terms are Cash in Advance (C.I.A.) until credit has been approved or rated. Please send full credit information and references and allow time for Credit Department approval.

For all established accounts, payment is due within thirty (30) days from the invoice date. Neutral Posture (NP) reserves the right to change or cancel the terms of sale based on volume, credit rating and/or credit information. Prepayment, whole or in part, may be requested at any time at the discretion of the corporate office.

Past due accounts are subject to a 1.5% late charge or maximum amount permitted under local law, for each thirty (30) days the outstanding balance remains open after the due date.

Withholding of payments based on carrier damages, shortages or other disputes is illegal and subject to charges.

ORDERING

All orders must be in writing; faxed, e-mailed or mailed. The product model number(s) contained in the order acknowledgment shall be the final expression of the order. A purchase order is not binding on NP until customer has received NP's order confirmation or acknowledgment. Orders must have a contact name and phone number. Orders may not be cancelled without written consent of Neutral Posture.

To expedite complete/correct entry of your order, be certain all model numbers, quantities, colors and area identifications are completely specified. Also, include complete purchase order number(s), bill-to and ship-to addresses, a contact name and specific shipping dates required.

Orders should be sent to:
Neutral Posture
3904 N Texas Avenue Bryan, TX 77803
979.778.0502 (Option 2)
800.446.3746
979.778.0408 FAX
E-mail: orderentry@neutralposture.com

When an order is received, it is assigned a scheduled ship date. That date is shown on the customer's acknowledgment.

Purchase orders may not be changed or cancelled, in whole or in part, without prior written consent of NP. Changes may affect delivery dates. Expenses incurred because of changes shall be charged to customer. In the event of cancellations, customer will be liable for reasonable cancellation charges established by NP. Orders for special product, orders including customer's own material (COM) and orders pursuant to expedited delivery programs, may not be cancelled.

A minimum of 3% of net expedite fee will be charged for orders requiring less than standard lead times.

PRICES

Prices are subject to change without notice. List prices shall be those in effect on the date of receipt of purchase order unless shipment is requested more than ninety (90) days after order entry in which case prices in effect on the date of shipment apply. Prices in effect at time of shipment prevails in the event of a discrepancy.

TAXES

All sales, use, excise and other taxes applicable to the sale of the products shall be paid by customer. If customer claims an exemption from any tax, customer shall submit to NP the appropriate exemption certificates.

LEAD TIME

Quick Ship lead time is five (5) business days for products noted with Quick Ship in the price list for quantities of 25 chairs or less. 5 day Quick Ship must be requested on purchase order and is not guaranteed until acknowledged by corporate office. Lead times can vary due to fluctuation in production capacity. It is always best to confirm lead time with Customer Service. Standard lead time is 3 - 4 weeks for orders that are not Quick Ship and/or Quick Ship quantities of 26 - 300 units. For larger orders contact Customer Service for lead time.

A minimum 3% of net expedite fee will be charged for orders requiring less than standard lead times. Less than standard lead time is clarified as less than 5 business days for Quick Ship models/quantities or less than 3 - 4 weeks on non-Quick Ship models. Customer to contact Customer Service prior to submitting the order to confirm expediting is available for their specific order.

CUSTOMER'S OWN MATERIAL

A customer who requests a fabric or other surface material not standard to NP's line of products (COM), must submit samples of the requested material to NP prior to entry of a customer order. NP will determine if the material is suitable to its manufacturing processes and products. The customer shall identify the COM to meet any applicable requirements of Underwriters Laboratories, CAL 117-2013, and/or Canadian Standards Association. If the COM is acceptable, NP will then establish a price for using the COM. For a description of the procedures for submitting samples and testing, contact Customer Service. NP shall have no responsibility for the appearance, condition, performance, durability, colorfastness or any other physical attribute of the COM. Customer shall indemnify and hold NP harmless for any damages, injuries or losses arising out of or related to use of the COM on the product.

STORAGE FEE

Any changes made by the customer to postpone the delivery date on orders which have already gone into production, will be charged a storage fee. This fee will be applied to both partially and fully built orders. NP will advise of fee prior to applying charge.

TERMS AND CONDITIONS

SHIPPING

Most NP products include shipping. All standard discount orders are F.O.B destination delivered by way of parcel or freight carrier service dock to dock within the forty-eight (48) contiguous United States, and the District of Columbia. NP will designate the shipping mode and carrier based on geographical location and best service as defined by our Logistics Department.

For orders shipping outside the forty-eight (48) contiguous United States, and the District of Columbia, customer pays shipping from port of embarkation to destination and order will be shipped "best way". Customer will incur additional charges if they choose to specify a freight carrier.

Any order requiring special delivery service, other than normal dock to dock delivery, will incur additional charges. These services include, but are not limited to residential delivery, limited access delivery, lift gate service, inside delivery, call before delivery, re-routed deliveries, specific delivery date/time requests or congestion fees. These charges will be quoted at customer request.

Conditions beyond the control of NP, including weather, available facilities and traffic conditions, may affect exact time of delivery. NP shall not be responsible for specific carrier delivery date or time unless it has made a specific delivery commitment, in writing.

Delivery date and time are at the discretion of the carrier within reasonable transit time unless special arrangements have been agreed to in writing between customer and NP prior to shipment.

Accessorial Charges (Net)

Delivery Appointment Required
Inside Delivery/Pick Up
Items Over 96 Inches
Lift Gate Required
Limited Access Delivery
Notification/CBD
Residential Delivery
Ship Fully Assembled
Pre-delivery Notification
Re-delivery/Return Trip

Contact Customer Service at
customerservice@neutralposture.com
or 979.778.0502 for pricing.

DELAY/FORCE MAJEURE

Neutral Posture shall not be liable for failure to perform or for delay in performance due to fire, flood, strike or other labor difficulty, act of God, act of any governmental authority or of the customer, riot, embargo, fuel or energy shortage, wrecks or delay in transportation, inability to obtain necessary labor, materials or manufacturing facilities from usual sources or failure of suppliers to meet their contractual obligations, or due to any cause beyond its reasonable control. If any such event occurs, Neutral Posture may extend delivery dates by a period of time necessary to overcome the effect of such delay, allocate available product or cancel any purchase order.

FREIGHT DAMAGE

Upon receipt of shipment consignee is responsible for checking delivery for shortages or signs of damage. If a problem is discovered, bring it to the driver's attention immediately. If any of the goods called for on the Bill of Lading are shorted or damaged, consignees should not accept them until the carrier makes a notation on the freight bill of the shorted or damaged goods. The more precise the notation, the easier the claim can be resolved. NP's responsibility ceases when the consignee signs the freight delivery receipt as received in good condition. Shipping claims must be made within thirty (30) days of shipment delivery.

RETURNS

The return of product without written authorization by NP shall not be accepted. All merchandise returns must be pre-approved by the corporate office and sent freight prepaid. Contact the Warranty Department, warrantyrequest@neutralposture.com, to receive a Return Merchandise Authorization (RMA) number for any return. RMAs are valid for thirty (30) days and any returned merchandise without a RMA number will be refused.

No deductions from any NP invoices can be made for return merchandise until it is approved by the corporate office. No deductions will be honored until returned goods are processed through our Quality Control Audit.

All returns for canceled orders must be pre-approved by the corporate office and sent freight prepaid. No returns will be authorized unless our inventory allows it, the parts are in good reusable condition and it was sold within the last thirty (30) days. Authorized seating returns will be charged a thirty percent (30%) (twenty percent (20%) for GSA) restocking fee, by agreement, to cover handling, inspection, stocking and repackaging. Authorized systems returns are subject to a forty-five percent (45%) of list restocking charge. Products not currently offered for sale by NP (including COM) shall not be authorized for return. All returned products must be unused, in original condition and in the original NP packing cartons. No refund or credit will be given for damaged products.

WARRANTY CLAIMS

Neutral Posture reserves the right to specify that items or parts claimed to be defective, be returned to the factory for our inspection. If the claim is justified, repair or replacement of defective parts under warranty will be made through NP at no cost to the customer. NP will, at its discretion, reimburse the furniture dealer for labor (actual costs only) on warranty parts. The furniture dealer must submit a quote to be approved prior to service. If approved, the furniture dealer must then submit an invoice to NP for reimbursement after the service is completed. Freight for products and parts covered under warranty will be covered for the forty-eight (48) contiguous states, and the District of Columbia, with the method of shipping at NP's discretion. All claims must include the product serial number. NP will have no warranty obligation if the product was subjected to abuse, alteration, misuse, negligence or accident or if the user fails to perform the proper maintenance for the product.

warrantyrequest@neutralposture.com

QUICK SHIP OVERVIEW

Neutral Posture's Quick Ship program allows customers to receive selected items sooner, for no extra charge. Items available on the Quick Ship program will be manufactured and shipped within 5 business days of an accurately specified order. Orders must be designated as Quick Ship on the PO in order to be processed as Quick Ship.

AVAILABLE CHAIRS	MAX QTY
1000 Series	25
5000 Series	25
6000 Series	25
8000 Series	25
Big & Tall	25
Cozi	25
Cozi 24/7	25
E-Series	25
Icon	25
Knomi	25
Renati	25
Right Chair	25
U4ia	25
Ulius	25
XSM	25

QUICK SHIP FABRICS

Grade 1

Ranchero	Black	230609
Spacer	Pewter	200651
Spacer	Ink	200649
Spacer	Black	200648
Spacer	Wine	200650

Grade 2

Ace	Toast	200714
Ace	Peony	200710
Ace	Char	200703
Ace	Midnight	200709
Ace	Jet	200707

Grade 3

Cloud 9	Red Dawn
Cloud 9	Midnight Sky
Cloud 9	New Haze
Cloud 9	Fog
Cloud 9	Thunder
Revive	Ebony
Revive	Goose
Revive	Ink
Revive	Metal

WARRANTY

EFFECTIVE APRIL 2017

Neutral Posture warrants to the original customer from the date of purchase that the products NP manufactures and sells to the customer are free of defects in workmanship and materials under normal use during the applicable warranty period set forth below.

Normal use is defined as wear which occurs in an office environment during the course of a normal single-shift usage workday (8 hours per day/5 days per week). NP products used in an environment exceeding 8 hours per day/5 days per week, are warranted to be free from defects in workmanship and materials for a period of two (2) years.

NP's warranty obligation is limited to the replacement or repair, at NP's discretion, of defective products which have been reported by the original customer to be defective in workmanship or material and which are found to be so by NP upon inspection. Defective products shall be returned at the discretion of the corporate office and all returns must be authorized in advance. NP will assume no responsibility for any labor charges.

Freight for products and parts under warranty will be covered for the forty-eight (48) contiguous United States, and the District of Columbia with the method of shipping at NP's discretion.

The user shall be responsible for all maintenance service, which includes but not limited to: lubricating and cleaning of the product, assembly, adjustment, checking all screws every six months and performing operation checks.

PRODUCT AND PERIOD OF WARRANTY

12 Years

All products and components except as noted below

10 Years

Chair controls, pneumatic cylinders, casters, glides, arms and plastic components

5 Years

StandUp®, StandUp®A1, inflatable lumbar, anti-fatigue mats, footrings, footrests, NeXtep®, CPU holders, monitor arms, keyboard trays, keyboard mechanisms, Connexion Arm®, foam, mesh material, Guardian®

3 Years

Upholstery excluding leather, Ultraleather™, NovaSuede®, UltraSuede®, Finesse®, Graded In, COM or COL

2 Years

StandUp®X1, Rovi, tablet holder, forearm supports

Replacement Parts

Warranted for two (2) years or the balance of the original warranty, whichever is longer

Engineer-to-Order Product

NP warrants all Engineer-to-Order products to be free from defects in workmanship given normal use and care for three (3) years of single-shift service

EXCLUSIONS

- The product was not purchased new from NP
- The product was subjected to abuse, alteration, misuse, negligence or accident
- Damage caused by a carrier
- Normal wear and tear or acts or omissions of parties other than NP (including user modification, improper use or installation of products)
- Colorfastness, matching of color, fabric puddling, or wearing qualities of any material
- Neutral Posture is not responsible for slight differences in fabric color due to supplier dye lot differences on large orders or on repeat orders placed at later dates from the original order
- Leather, Ultraleather™, NovaSuede®, UltraSuede®, Finesse®, COM, COL or any other third party materials applied to product as specified by the customer including attributes such as appearance, durability, quality, behavior, colorfastness, performance, etc.
- Non-compliance with installation and maintenance instructions
- Modifications or attachments to the product that are not approved by NP and product failures resulting from such modifications or attachments
- Damage caused by cleaning chemicals
- Dye transfers caused by external contaminants (including clothing and accessory dye such as those used on denim jeans)
- Substitution of any unauthorized non-NP components for use in the place of NP components
- Products that are exposed to extreme environmental conditions and/or have been subject to improper storage
- Damage from sharp objects such as writing utensils, heeled shoes, scissors, jewelry or keys

The warranty printed above is the only warranty applicable to these products. All other warranties expressed or limited, including but not limited to the implied warranties of merchantability and fitness for a particular purpose are disclaimed.

24/7 CONTINUOUS-SHIFT

Covers all components of the chair for a period of five (5) years to the original customer from the date of purchase except for upholstery and inflatable lumbar. Only upholstery with a double rub rating of over 1M is warranted for the complete 5-year period.



Availability:

Big & Tall Series	Included in Price
Cozi 24/7	Included in Price
NP Series	\$290 List Up Charge Per Chair
All other chairs	Contact Customer Service, customerservice@neutralposture.com

Always confirm pricing/availability with Customer Service.

GENERAL INFORMATION

PATENT INFORMATION

Neutral Posture® Chair	U.S. Patent #4,552,404
AbStool®	U.S. Patent #6,877,812
360° Adjustable Arms	U.S. Patent #7,104,606
Adjustment Guide	U.S. Patent #6,296,312
Balance™	U.S. Patent #D458,777
Connexion® Arm	U.S. Patent #D541,061
ElementAl®	U.S. Patent #8,955,905
Fring® Footrest	U.S. Patent #D588,145
	U.S. Patent #6,142,571
Inflatable Lumbar	U.S. Patent #6,607,246
	U.S. Patent #6,220,663
	U.S. Patent #6,290,295
Keyboard Tray	U.S. Patent #D463,441
NeXtep®	U.S. Patent #7,036,886
N•Position™	U.S. Patent #D557,513
StandUp®	U.S. Patent #7,048,236
Cover for a Seating Device	U.S. Patent #D647,353
Other Patents Pending	

CERTIFICATION

Independent tests show that all NP chairs meet or exceed current ANSI/HFES 100-2007, ANSI/BIFMA and California 117 certification standards. Certain NP products meet California Technical Bulletin 133 and task intensive certification standards. All cylinders are rated Class 4 or better by UNI standards.

DESIGN

NP reserves the right to make changes and improvements in design and materials and to discontinue parts and components at their discretion.

WOMEN'S BUSINESS ENTERPRISE (WBE)

This certification is administered by the Women's Business Enterprise National Council (WBENC) and is used to qualify potential vendors as credible diversity suppliers. NP is certified as a WBE by WBENC.

WOMAN OWNED SMALL BUSINESS (WOSB)

The U.S. Small Business Administration's WOSB Federal Contract Program provides greater access to federal contracting opportunities for WOSBs. The program allows contracting officers to set aside specific contracts for certified WOSBs and helps federal agencies achieve the existing statutory goal of five percent of federal contracting dollars being awarded to WOSBs. NP is certified as a WOSB by WBENC.

HISTORICALLY UNDERUTILIZED BUSINESS (HUB)

The Texas Historically Underutilized Business (HUB) program encourages the use of HUBs in state procurement and provides information to minority and woman-owned businesses on the state's procurement process. NP is certified as a HUB.

BUSINESS AND INSTITUTIONAL FURNITURE

MANUFACTURER'S ASSOCIATION

NP is a member of the Business and Institutional Furniture Manufacturer's Association (BIFMA). Tests developed by BIFMA and approved by the American National Standards Institute (ANSI) determine the strength and durability of office furniture in its everyday use. Although this testing does not serve as a warranty or guarantee, NP standard products within this price list meet or exceed applicable ANSI/BIFMA X5.1-2011, BIFMA G1-2001 and ANSI/HFES 100-2007 standards. Combinations of options added on to the standard products may not meet ANSI/ BIFMA standards. Those combinations which do not meet ANSI/BIFMA standards are not available on GSA. Additionally, most seating is BIFMA level 2 certified. For more information, contact Customer Service at customerservice@neutralposture.com.

SCS INDOOR ADVANTAGE CERTIFICATION

All NP seating products are certified by SCS Global Services for indoor air quality.

CUSTOM LOGOS

Your company, university, mascot, etc as a custom logo in embroidery can be placed on most fabrics or in Cloud 9™. Contact Customer Service at customerservice@neutralposture.com for details and cost.

CLEANROOM TO CLASS 100

Independent testing according to Federal STD 209E (correlates to ISO-14644C Class 5) confirms NP Cleanroom seating meets or exceeds Class 100 requirements. NP Cleanroom models are designed to prevent particulates in Cleanroom environments. In addition to top-quality vinyl upholstery, a HEPA filtration system in the seat and backrest prevent particulate release.

Available Models

Available Models	Upcharge (List)
Big & Tall	\$120
Cozi	\$120
Cozi 24/7	\$120
NP55500-D1	\$120
NP55600-D1	\$120
AbChair (Urethane)	\$120
Adapta Stool	\$120
Stratus Upholstered	\$120
Stratus Urethane	\$70
Graphite	\$70
Geo	\$70

NEUTRAL POSTURE'S COMMITMENT TO NON-OBSOLESCENCE.

To address the way people work today and the ever changing work environment, Neutral Posture introduces new and improved products. These introductions are designed to retrofit existing customer inventory. Enhancements mean nothing if you can't adapt. If a product is enhanced, function changes or demand becomes low, Neutral Posture will provide compatible products across generations of equal or similar appearance and operational characteristics in terms of form, fit and function. Because mills and suppliers discontinue fabrics, laminates and paints with little or no notice, Neutral Posture is not able to guarantee finish availability. When possible notification of discontinued finishes to dealers and end users will be made. Neutral Posture will provide a 90-day window from the date of discontinuation in which we will guarantee availability of the finish.

GENERAL INFORMATION

CAL 133

Almost every model in the NP family of seating products meets the specifications for California Technical Bulletin 117, the industry standard for upholstered furniture. Additionally, NP chairs can be upgraded to meet the more stringent, California Technical Bulletin 133 standard, which is required by the California Bureau of Home Furnishings and Thermal Insulation for contract seating used in public facilities.

Standard CAL 133 Models and Options

Fabric/Vinyl \$265 Upcharge (List)
 Leather Contact
 customerservice@neutralposture.com

Available Chairs	Options	Exceptions
5000 Series	All	Inflatable Lumbar
6000 Series	All	Inflatable Lumbar No Pillow Top All Headrests
8000 Series	All	Inflatable Lumbar All Headrests
Big & Tall	All	Inflatable Lumbar Arm Shroud Pillow Top All Headrests
AbChair	All	Urethane AbRest Cleanroom
Cozi	All	
Cozi 24/7	All	
Dice	All	Arms
Right Chair	All	
U4ia	All	

NP can also utilize COM for the CAL 133 upgrade if the material is an inherently flame retardant (FR) material, like Trevira® or Avora®. For large orders and corporate standards programs, NP can also facilitate a lab-supervised burn test for each chair/upholstery combination. These tests will be negotiated and supervised through NP's Engineering Department.

All models that comply with CAL 133 will be labeled accordingly on both the packing slip and the serial number description tag. Additionally, they will contain a label with the following notice:

Notice: This chair is manufactured in compliance with California Technical Bulletin 133 and meets the flammability requirements of the California Bureau of Home Furnishings.

WARNING

This product can expose you to chemicals including (Antimony Oxide), which is known to the State of California to cause cancer. For more information, go to www.P65Warnings.ca.gov/furniture.

ELECTROSTATIC DISCHARGE (ESD) SEATING

NP ESD models are tested to meet the requirements of today's ESD environment with conductive components and fabrics (1% carbon fiber with surface resistivity no greater than 1.3 x 10⁶ ohms/sq.cm when test in accordance with ANSI/ESD STM12.1-2013). ESD chairs are an integral part of an effective ESD system that includes a conductive floor or mat to complete conductive path.

Upholstery

- Conductive cloth or vinyl

Options

- 20" Footring
- Upholstered Back Outer
- 4" Height Adjustable Arms
- T Arms
- Drag Chain

Features

- Polished Aluminum Base

Available Chairs

Available Chairs	Upcharge (List)
5000 Series	\$290
6000 Series	\$290
8000 Series	\$290
AbChair	\$290
Adapta	\$290
Big & Tall	\$290
Cozi	\$290
Cozi Stool	\$290
Cozi 24/7	\$290
Stratus Upholstered	\$290
XSM – Extra Small	\$290

Upcharge added to graded price. Many other options and features available at an added charge. Please refer to page 12 for pricing.

ESD Order Form

Client _____

Contact Name _____

Phone Number _____

Fax Number _____

Email Address _____

City _____

State _____ Zip _____

Purchase Order Number _____

Quantity _____

Model # _____ List Price _____

Send completed form with order to:

Neutral Posture, Inc.
3904 N. Texas Avenue
Bryan, TX 77803
979.778.0502 (Option 2)
800.446.3746
979.778.0408 FAX
orderentry@neutralposture.com

Available Chairs

- 5000 Series
- 6000 Series
- 8000 Series
- AbChair
- Adapta
- Big & Tall (*Arms are fixed*)
- Cozi
- Cozi Stool
- Cozi 24/7
- Icon
- Stratus Upholstered
- XSM – Extra Small

ESD Option – Per Chair

Upcharge

Standard ESD Package (E)

\$290

- Convert to equivalent ESD cylinder
- Convert to aluminum base
- Convert to equivalent ESD casters or glides
- The standard ESD chair is without arms
- ESD wiring & braiding
- Ships fully assembled

Select Additional ESD Options

- | | | |
|--------------------------|--|-------|
| <input type="checkbox"/> | Add conductivity to Upholstered Back Outer (U)
<i>Only available on Neutral Posture® Series</i> | \$20 |
| <input type="checkbox"/> | 4" Adjustable Arms with conductivity | \$240 |
| <input type="checkbox"/> | Add conductivity to 20" Chrome Footring (R2) | \$20 |
| <input type="checkbox"/> | Drag chain
<i>Includes chain and conductivity</i> | \$30 |

Total ESD up charge per chair \$ _____

Customer's Own Material (COM) Form

Dealer Name _____

Contact Name _____

Address _____

City _____ State _____ Zip _____

Phone Number _____

Fax Number _____

Email Address _____

Client Name _____

Fabric Source (Mill) _____

Fabric Pattern Name _____

Fabric Pattern Number _____

Fabric Color _____

Backer Type (if any) _____

Fabric Orientation

Attach a fabric sample with the correct orientation

TOP

BOTTOM

Send completed form and sample yardage to:

Neutral Posture, Inc.
Attention: Customer Service
3904 N. Texas Avenue
Bryan, Texas 77803
(979) 778-0502 or
customerservice@neutralposture.com

We will make sure material is sent to the correct plant(s) for testing.

Preferred memo sample size is 12" x 12". Additional yardage may be required for testing.

Please make sure fabric has been approved for CAL117 flammability testing. Most industry fabrics have been tested and approved. NP may not use a fabric that has not been approved for CAL117.

NP will notify you of test results.

Contact COM Department for pricing/grading. COM yardage may vary, depending on repeat pattern. COM not covered under warranty.

All COM subject to NP testing and approval.

COM form must accompany fabric.

If fabric is a stripe please select the correct orientation:

Horizontal Vertical

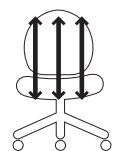

Is there a desired top?

Yes _____ No _____

If so please specify.

GSA Contract Overview

GSA CONTRACT

We have had a contract with GSA for over 20 years and they continue to be our most favored customer.

NP is dedicated to helping government agencies meet their facilities and acquisition needs. NP is registered with the System For Award Management (SAM) formerly Central Contractor Registry (CCR) with ORCA certifications, has an assigned cage code of 0UTL8 and is eligible to receive federal contract awards. NP is also recognized as a Woman Owned Small Disadvantaged Business by the U.S. Small Business Administration (SBA).

WOMEN-OWNED SMALL BUSINESS (WOSB) / ECONOMICALLY DISADVANTAGED WOMEN- OWNED SMALL BUSINESS (EDWOSB)

The U. S. Small Business Administration (SBA) issued the Final Rule to amend its regulations governing small business contracting procedures. The SBA has increased the emphasis and awareness of contracting mandates regarding the new 5% spend mandate for WOSB/EDWOSB's similar to those in place for 8a, SDV and HUB Zone businesses.

The SBA has also implemented a Sole Source vehicle for Economically Disadvantaged Women-Owned Small Businesses (EDWOSB). Neutral Posture, a small business manufacturer, received this certification in April of 2016.

Our Packaged Office contract includes many great manufacturing partners and we are willing to team with other manufacturers to support strong GSA Dealers and meet the needs of our customers.

For more information please visit
NeutralPosture.com/WOSB

GSA OVERVIEW

GSA Contract# GS-27F-0014Y

Schedule 71 – Furniture

SIN 71-1	Packaged Office
SIN 71-205	Chairs-Dining Room, Desk, Side, Period Style & Bar Stools
SIN 711-1	Furniture Systems & Workstation Clusters
SIN 711-11	Tables & Accessories
SIN 711-18	Multipurpose Seating
SIN 711-19	Stacking Chairs & Dollies
SIN 711-2	Worksurfaces, Workstations, Computer Furniture & Accessories
SIN 711-3	Filing and Storage Cabinets, Shelves, Mobile Carts, Dollies, Racks & Accessories
SIN 711-91	Project Management (Furniture Related)
SIN 711-94	Office Design/Layout Services
SIN 711-95	Installation Services
SIN 71-500	Order-level Materials (OLMs)

NAICS CODES

337214	Office Furniture (except wood) Manufacturing
337211	Wood Office Furniture Manufacturing
337127	Institutional Furniture Manufacturing
423210	Furniture Merchant Wholesalers

NP products may be found on GSA Advantage.

AVAILABLE ON GSA

Products available on GSA as of March 2019. For the most current list of products available on GSA contact Customer Service or visit NeutralPosture.com.

SEATING

1000 Series
5000 Series
6000 Series
8000 Series
Adapta
Big & Tall
Balance
Cozi
Cozi 24/7
Cozi Guest
Dice
E-Series
Embrace
Embrace Guest
Equity^{NP}
Facet
Geo
Graphite
Icon
Knomi
NV
Renati
Right Chair
Right Chair Guest
U4ia
U4ia Guest
Ulius
Ulius Guest
XSM – Extra Small

WORKPLACE ACCESSORIES

Anti-fatigue Mats
Boost Monitor Arm
CPU Holders
Forearm Supports
Freedom Arm
Sit/Stand Monitor Arm
StandUp
StandUp A1
StandUp X1 – SUPX136BL
StandUp X1 – SUPX136WL
StandUp X1 – SUPX140BL
StandUp X1 – SUPX140WL
StandUp X1 – SUPX142BL
StandUp X1 – SUPX148BL
StandUp X1 – SUPX1CR36BL
StandUp X1 – SUPX1CR42BL
Tablet Holder

NOT AVAILABLE ON GSA

Products not available on GSA as of March 2019.

SEATING

AbChair
Guardian
NBF074
NBF075
P Arm
TheraGel Memory Foam

WORKPLACE ACCESSORIES

Ascension Arm
Easy Combo T43
Rovi
SoftTouch Keyboard Tray
StandUp X1 – SUPX136B
StandUp X1 – SUPX136W
StandUp X1 – SUPX142B
StandUp X1 – SUPX1CR42B

TERM DATE 6/26/2012 – 6/26/2022

- 1a. Special Item Numbers Awarded**
- | | |
|------------|--|
| SIN 711-1 | Furniture Systems and Workstation Clusters |
| SIN 711-11 | Tables and Accessories |
| SIN 711-18 | Multipurpose Seating |
| SIN 711-19 | Stacking Chairs and Dollies |
| SIN 711-95 | Installation Services |
| SIN 711-2 | Worksurfaces, Workstations, Computer Furniture and Accessories |
| SIN 711-3 | Filing and Storage Cabinets, Shelves, Mobile Carts, Dollies, Racks & Accessories |
| SIN 711-91 | Project Management (Furniture Related) |
| SIN 711-94 | Office Design/Layout Services |
| SIN 71-1 | Packaged Office |
| SIN 71-205 | Chairs-Dining Room, Desk, Side, Period Style and Bar Stools |
| SIN 71-500 | Order-level Materials (OLMs) |
- 1b. Lowest Priced Item**
- | | | |
|------------|--------------------------|----------|
| SIN 71-1 | Call Corporate Office | |
| SIN 71-205 | Call Corporate Office | |
| SIN 711-1 | EP3P29 Single Post | \$32.55 |
| SIN 711-11 | TBR30X-L1/P1 Round Table | \$337.50 |
| SIN 711-18 | NCUGG1 Urethane | \$151.20 |
| SIN 711-19 | NSID115 Grade C | \$336.00 |
| SIN 711-2 | 11 Keyboard Tray | \$65.10 |
| SIN 711-3 | SPTRY Pencil Tray | \$5.95 |
| SIN 711-95 | Not Applicable | |
| SIN 71-500 | Not Applicable | |
- 1c. Installation Rate — SIN 711-1, 711-3, 711-11**
\$51.50 per hour (non-union inclusive IFF)
\$106.25 per hour (union inclusive of IFF)
- Project Management Fee — SIN 711-91**
Senior Project Manager \$75 per hour (inclusive IFF)
Project Manager \$55.58 per hour (inclusive IFF)
Project Coordinator \$50 per hour (inclusive IFF)
- Design/Layout Fee — SIN 711-94**
\$65 per hour (inclusive IFF)
\$85 per hour CADD service (inclusive IFF)
- 2. Maximum Order**
- | | |
|------------|-------------|
| SIN 71-1 | \$5,000,000 |
| SIN 71-205 | \$1,000,000 |
| SIN 711-1 | \$500,000 |
| SIN 711-11 | \$500,000 |
| SIN 711-18 | \$200,000 |
| SIN 711-19 | \$200,000 |
| SIN 711-2 | \$200,000 |
| SIN 711-3 | \$500,000 |
| SIN 711-91 | \$150,000 |
| SIN 711-94 | \$150,000 |
| SIN 711-95 | \$150,000 |
| SIN 71-500 | \$0 |
- 3. Minimum Order**
All SINs \$50
- 4. Geographic Coverage**
CONUS & OCONUS
- 5. Point of Production**
3904 N. Texas Avenue, Bryan, Brazos County, Texas, USA
- 6. Discount from List Price**
Seating/Workplace Accessories
SIN 711-2, 711-18, 711-19, 711-205 — Discount 58%
Systems
SIN 711-1, 711-3, 711-11 — Discount 70%
- 7. Quantity Discounts**
No discount tiers have been negotiated.
- 8. Prompt Payment Terms**
Net 30 Days
- 9. Government Purchase Cards Accepted**
Visa/Master Card
- 10. Foreign Item**
None
- 10a. Time of Delivery**
5 – 90 days after receipt of order
- 10b. Expedited Delivery**
Expedited delivery available. Contact NP Customer Service.
- 10c. Overnight and 2-day Delivery**
Available with an upcharge. Contact NP Customer Service.
- 12. F.O.B. Points**
Destination/CONUS, within the 48 contiguous states and the District of Columbia. Port of embarkation for delivery to Alaska, Hawaii, Puerto Rico, the Virgin Islands and U.S. Government installations overseas.
- 13. Ordering Address**
Neutral Posture, Inc.
attn: Order Entry/ * or dealer
3904 N. Texas Avenue
Bryan, TX 77803
979.778.0502
800.446.3746
fax 979.778.0408
orderentry@neutralposture.com
* Authorized Dealers should be cited on order
- 14. Payment Address**
Neutral Posture, Inc.
3904 N. Texas Avenue
Bryan, TX 77803
- 15. Warranty Provision**
Neutral Posture's commercial warranty applies.
- 16. Export Packing Charges**
Contact NP Customer Service for quote.
- 17. Terms and Conditions of Government Purchase Card**
Government purchase cards will be accepted for purchases at prices shown in this authorized price list (no additional discount offered).
- 18. Terms and Conditions Of Rental, Maintenance, and Repair**
Not applicable
- 19. Terms and Conditions of Installation**
Installation and instruction are available from authorized dealers. Please contact your local NP Dealer for pricing.
- 20. Terms and Conditions of Repair Parts**
Repair parts are offered at the agreed upon discount from the NP repair parts price list in effect at the time the repair parts are ordered.
- 20a. Terms and Conditions for Any Other Services**
GSA has accepted all of our standard terms and conditions as noted on page 6-7.
- 21. List of Service and Distribution Points**
Not applicable
- 22. List of Dealers**
Please contact NP, or visit NeutralPosture.com for the name of your nearest authorized Dealer.
- 23. Preventive Maintenance**
Not offered or applicable
- 24. Environmental Attributes**
Not applicable
- 25. Other Information**
Tax Identification Number (TIN): 74-2983577
DUNS: 61-0339723
Cage Code: OUTL8
NAICS: 337214
- 26. SAM**
NP is registered in System For Award Management (SAM).
NOTE: It is mandatory that all Government purchase orders be made out to NP only. Local Dealers are not authorized to accept purchase orders, issue invoices or receive payment of Government funds for these items without serious violation of this Federal Supply Schedule Contract.

HIGH PERFORMANCE SEATING

Neutral Posture's high performance chairs are truly at the top of the line in the industry when it comes to comfort. The chairs offer up to 15 adjustments ensuring that the chair will fit every inch of your body just right. Our high performance chairs are made to fit anyone and everyone, with our Neutral Posture Series chairs fitting anyone within the 5th percentile female to the 95th percentile male and the XSM and the Big and Tall fitting anyone outside that

range. These chairs are also well known for their weight dispersing abilities. Weight dispersion presents a much more comfortable seat by spreading out the weight of your body, lowering the pressure by 50%. The high performance seating is engineered as a tool to empower those who use it. The high performance seating can be used for long periods of time promoting productivity and are just as comfy at the end of the day as they were at the beginning.

HIGH PERFORMANCE SEATING

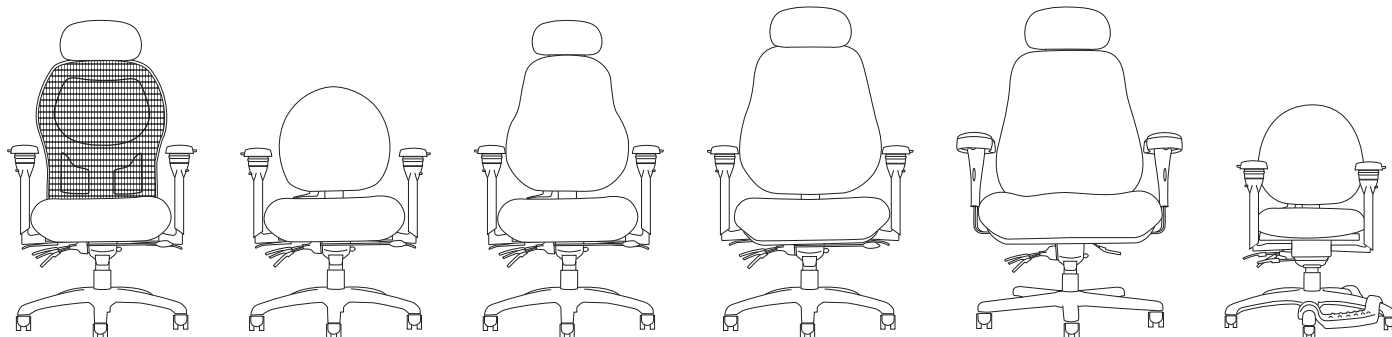

HEADREST OPTIONS

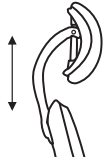

HE HEADREST

Black Vinyl

- For mesh back*
- Height

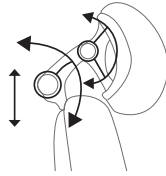

H4 DUAL PIVOT

Matching Upholstery

- Height
- Depth
- 2 Pivot Points

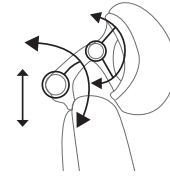

H5 DUAL PIVOT

Black Faux Leather

- Height
- Depth
- 2 Pivot Points

BACK OPTIONS



1 BACK

- Not height adjustable
- Mesh back
- Independent lumbar adjustment
- Easily converts to an upholstered back with optional sleeve

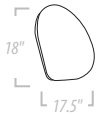

5 BACK

- Height adjustable
- Mid back with minimal lateral contour
- Excellent lower back support with inflatable lumbar
- Small profile
- Good choice for tight areas



8 BACK

- Height adjustable
- High back with moderate lateral contour
- Excellent upper & lower back support with inflatable lumbar
- Excellent choice for all applications

6 BACK

- Height adjustable
- High back with minimal lateral contour
- Excellent upper & lower back support with inflatable lumbar
- Tallest, widest backrest
- Good choice for larger users

SEAT OPTIONS



5 SEAT

Medium Seat, Minimal Contour

- 3" thick foam eliminates "bottoming out"
- Fits widest range of population



8 SEAT

Large Seat, Minimal Contour

- Large dimension accommodates larger users
- 3" thick foam eliminates "bottoming out"

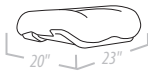

6 SEAT

Medium Seat, Moderate Contour

- Contoured seat design minimizes seated pressure
- 3" thick foam eliminates "bottoming out"
- Arm post notches reduce armrest width by 2"



9 SEAT

Large Seat, Deep Contour

- Largest contoured seat
- Designed for larger users & to support forward tilt (i.e. neutral posture)
- Maximizes surface contact to disperse seated pressure



7 SEAT

Medium Seat, Deep Contour

- Most contoured seat design
- Designed to support forward tilt (i.e. neutral posture)
- Maximizes surface contact to disperse seated pressure

CHAIR MECHANISM

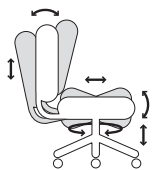

0 MULTI-FUNCTION

- Center pivot
- Swivel 360°
- Pneumatic seat height
- Back height
(not available on 1000 Series)
- Seat angle
- Seat tension
- Independent back angle
- Forward tilt-stop
- Seat slider

ARM OPTIONS

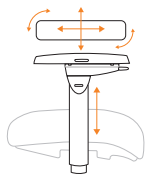

0 ARM 5-way 360°

- Height, width, depth & pivot adjustable
- 24 positive-lock angle positions in 360° range
- Arm pads slide in & out for additional width adjustment
- Arm pads slide back & forth allowing closest access to work

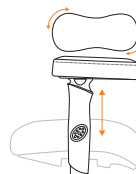

6 ARM Oversized Black Vinyl Arm Pads

- Height, width & pivot adjustable
- Oversized, padded arm pads provide large, extra soft surface
- 22 positive-lock angle positions in 360° range
- 180° rotation alternates long/short end positioning for access to work

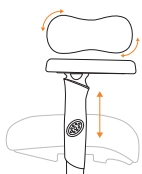

3 ARM 360° Swivel w/Oversized Urethane

- Height, width & pivot adjustable
- Oversized arm pads provide large, soft surface
- 22 positive-lock angle positions in 360° range
- 180° rotation alternates long/short end positioning for access to work

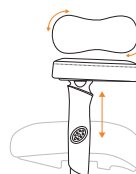

7 ARM Oversized Fabric/Leather Arm Pads

- Height, width & pivot adjustable
- Oversized, padded arm pads provide large, extra soft surface
- 22 positive-lock angle positions in 360° range
- 180° rotation alternates long/short end positioning for access to work

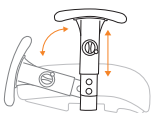

4 ARM Swing

- Unique design swings arm down & out of the way
- Height, width & swing-down adjustable
- Excellent for multi-user applications where not all want armrests



P ARM 360° Swivel

- Height, width & pivot adjustable
- 22 positive-lock angle positions in 360° range
- 180° rotation alternates long/short end positioning for access to work

1000 Series

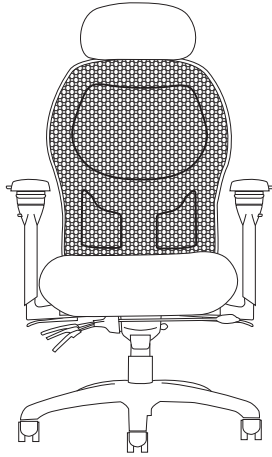

NPS1500-H5

Features

- Up to 14 active adjustments
- Mesh back
- Independent lumbar
- Generous foam for optimal comfort
- Convert mesh back to upholstered w/optional sleeve
- 2 headrest options

Standard Features

- 5-way 360° Arms
- Carpet Casters
- 26" Black Base
- 5" Cylinder
- Seat Slider

Need it Now? 5-day Quick Ship

Only standard features are available as Quick Ship unless otherwise noted.

QUICK SHIP ARMS

- 0 5-way 360°
- 5 No Arms

QUICK SHIP FABRICS

For available quick ship fabrics see page 8.

Step 1 — Model Number

Series Code	Back	Select a Seat	Select an Arm	Mech
NPS Neutral Posture Series	1 Mesh Back	5 Medium Seat, Minimal Contour 6 Medium Seat, Moderate Contour 7 Medium Seat, Deep Contour 8 Large Seat, Minimal Contour	0 5-way 360° \$0 3 360° w/Oversized Urethane \$75 4 Swing \$155 5 No Arms (\$140) 6 360° w/Oversized Black Vinyl \$225 7 360° w/Oversized Fabric/Leather \$265 P 360° Swivel \$0	0 Multi-function \$0 
NPS	1	5	0	0



NPS1500	NPS1600	NPS1700	NPS1800
\$1,238	\$1,305	\$1,316	\$1,316
\$1,298	\$1,365	\$1,376	\$1,376
\$1,358	\$1,425	\$1,436	\$1,436
\$1,428	\$1,495	\$1,506	\$1,506
\$1,498	\$1,565	\$1,576	\$1,576
\$1,578	\$1,645	\$1,656	\$1,656
\$1,658	\$1,725	\$1,736	\$1,736
\$1,748	\$1,815	\$1,826	\$1,826
\$1,838	\$1,905	\$1,916	\$1,916

40 x 26 x 26	40 x 26 x 26	40 x 26 x 26	40 x 26 x 26
56 lbs	56 lbs	61 lbs	61 lbs
21	23	23	23
17.5 – 22.5	17.5 – 22.5	17.5 – 22.5	18.25 – 23.25
15.5 – 18	16 – 18.5	16 – 18.5	18 – 20.5
F3° – R11°	F9° – R6°	F10° – R3°	F5° – R7°
19	19	19	19
21	21	21	21
95° – 114°	100° – 126°	103° – 123°	102° – 109°
3	3	3	3
7 – 11	7 – 11	7 – 11	6.5 – 10.5
15.75 – 22.25	15.75 – 22.25	18 – 22.25	18 – 22.25
26	26	26	26
1 yd	1 yd	1 yd	1 yd
28 x 26 x 24	28 x 26 x 24	28 x 26 x 24	28 x 26 x 24
66 lbs	66 lbs	71 lbs	71 lbs
KD	KD	KD	KD

All measurements are nominal and shown in inches. Specs may differ for stools.

- Grade 1
- Grade 2
- Grade 3
- Grade 4
- Grade 5
- Grade 6
- Grade 7
- Grade 8
- Grade 9

- Chair (H x W x D)
- Chair Weight
- Seat Width
- Seat Height
- Seat Depth
- Seat Angle
- Back Width
- Back Height
- Back Angle
- Lumbar Range
- Arm Height
- Arm Width
- Base Diameter
- COM Yardage
- Shipping Box (L x W x H)
- Shipping Weight
- Shipping Method

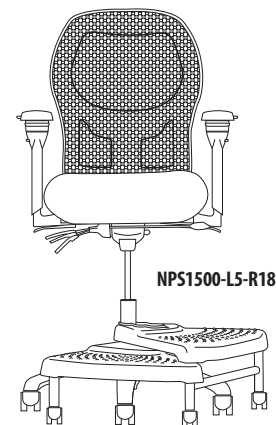

NPS1500-L5-R18

Step 2 — Add option codes after model number NPS1500 - __ - __

General		Casters/Glides		Chair Cylinders		Stool Cylinders		
CR	Cleanroom to Class 100	\$120	C1	Hard Floor	\$25	L1	3" Cylinder	\$0
CX	Coccyx Cutout	\$215	C2	Glides	\$25	L13	7" Dual Stage	\$55
	<i>Cloud 9, Revive, Top Shelf & M Plus</i>		C3	Occupied Braking	\$185	L14	10" Dual Stage	\$55
F	Fring® Footrest	\$50	C4	Unoccupied Braking	\$60			
	<i>Only available on (B0) base</i>		C8	Chrome Carpet	\$90	Headrests		
N	N-dulgent® Memory Foam	\$75	C9	Chrome Hard Floor	\$100	HE	Height Adjustable	\$60
N2	TheraGel™ Memory Foam	\$150					<i>Black vinyl</i>	
			Bases			H5	Dual Pivot	\$280
			B6	26" Polished Aluminum	\$140		<i>Black faux leather</i>	
				<i>Recommended with (L1)</i>		Connexion® Arm		
			B8	27" Brushed Aluminum	\$140	Z1	Connexion Arm	\$350
				<i>Recommended with (L1)</i>			<i>Only available on (5) & (6) seat</i>	
			B12	28" Black	\$110	Connexion® Arm Attachments		
			Continuous Shift Warranty			A1	Tablet Holder	\$149
			IU	Continuous-shift warranty	\$290		<i>Requires (Z1) Connexion Arm</i>	
						Stool Options		
Back Sleeve – Back of sleeve made w/Spacer						Footrings – for stool cylinders only		
S1	Grade 1	\$110				R1	18" Black Plastic	\$60
S2	Grade 2	\$160				R2	20" Chrome	\$80
S3	Grade 3	\$200				NeXtep® – for stool cylinders only		
S4	Grade 4	\$240				R8	8" w/Casters	\$185
S5	Grade 5	\$280				R10	10" w/Casters	\$185
S6	Grade 6	\$330				R18	8"/10" w/Casters	\$295
S7	Grade 7	\$380				RW8	Wide 8" w/Casters	\$295
S8	Grade 8	\$430				RW10	Wide 10" w/Casters	\$295
S9	Grade 9	\$480				<i>Also available w/glides.</i>		

For additional stool options see page 110.

5000 Series

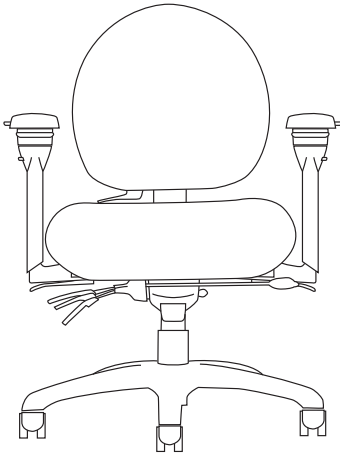

NPS5500

Features

- Up to 12 active adjustments
- Mid back & contoured seat designs
- Passive weight dispersion design
- Generous foam for optimal comfort
- Inflatable lumbar

Standard Features

- 5-way 360° Arms
- Carpet Casters
- 26" Black Base
- 5" Cylinder
- Seat Slider

Need it Now? 5-day Quick Ship

Only standard features are available as Quick Ship unless otherwise noted.

QUICK SHIP ARMS

- 0 5-way 360°
- 5 No Arms

QUICK SHIP FABRICS

For available Quick Ship fabrics see page 8.

Step 1 — Model Number

Series Code	Back	Select a Seat	Select an Arm	Mech
NPS Neutral Posture Series	5 Mid Back	5 Medium Seat, Minimal Contour 6 Medium Seat, Moderate Contour 7 Medium Seat, Deep Contour 8 Large Seat, Minimal Contour 9 Large Seat, Deep Contour	0 5-way 360° \$0 3 360° w/Oversized Urethane \$75 4 Swing \$155 5 No Arms (\$140) 6 360° w/Oversized Black Vinyl \$225 7 360° w/Oversized Fabric/Leather \$265 P 360° Swivel \$0	0 Multi-function \$0
NPS	5	5	0	0





NPS5500	NPS5600	NPS5700	NPS5800	NPS5900
\$1,284	\$1,352	\$1,362	\$1,362	\$1,399
\$1,344	\$1,412	\$1,422	\$1,422	\$1,459
\$1,404	\$1,472	\$1,482	\$1,482	\$1,519
\$1,474	\$1,542	\$1,552	\$1,552	\$1,589
\$1,544	\$1,612	\$1,622	\$1,622	\$1,659
\$1,624	\$1,692	\$1,702	\$1,702	\$1,739
\$1,704	\$1,772	\$1,782	\$1,782	\$1,819
\$1,794	\$1,862	\$1,872	\$1,872	\$1,909
\$1,884	\$1,952	\$1,962	\$1,962	\$1,999

36 x 26 x 26	36 x 26 x 26	36 x 26 x 26	36 x 26 x 26	36 x 26 x 26
52.5 lbs	52.5 lbs	57 lbs	57 lbs	57 lbs
21	23	23	23	25
17.5 – 22.5	17.5 – 22.5	17.5 – 22.5	18.25 – 23.5	17.5 – 22.5
15.5 – 18	16 – 18.5	16 – 18.5	18 – 20.5	19 – 21.5
F3° – R11°	F9° – R6°	F10° – R3°	F5° – R7°	F8° – R6°
17.5	17.5	17.5	17.5	17.5
17 – 21	17 – 21	16 – 20	17 – 21	16 – 20
102° – 122°	107° – 122°	107° – 124°	108° – 128°	102° – 118°
4	4	4	4	4
7 – 11	7 – 11	7 – 11	6.5 – 10.5	6.5 – 10.5
15.75 – 22.25	15.75 – 22.25	18 – 22.25	18 – 22.25	18.5 – 22.25
26	26	26	26	26
2 yd	2 yd	2 yd	2 yd	2 yd
28 x 26 x 24	28 x 26 x 24	28 x 26 x 24	28 x 26 x 24	28 x 26 x 24
62.5 lbs	62.5 lbs	67 lbs	67 lbs	67 lbs
KD	KD	KD	KD	FA

All measurements are nominal and shown in inches. Specs may differ for stools.

- Grade 1
- Grade 2
- Grade 3
- Grade 4
- Grade 5
- Grade 6
- Grade 7
- Grade 8
- Grade 9

- Chair (H x W x D)
- Chair Weight
- Seat Width
- Seat Height
- Seat Depth
- Seat Angle
- Back Width
- Back Height
- Back Angle
- Lumbar Range
- Arm Height
- Arm Width
- Base Diameter
- COM Yardage
- Shipping Box (L x W x H)
- Shipping Weight
- Shipping Method

Upholstered Back Outer		
U1	Grade 1	\$120
U2	Grade 2	\$140
U3	Grade 3	\$160
U4	Grade 4	\$180
U5	Grade 5	\$200
U6	Grade 6	\$220
U7	Grade 7	\$240
U8	Grade 8	\$260
U9	Grade 9	\$280

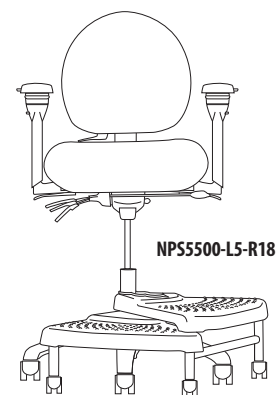

Step 2 — Add option codes after model number NPS5500 - __ - __

Continuous Shift Warranty

IU Continuous-shift warranty \$290

General

A Thoracic Support \$80

CR Cleanroom to Class 100 \$120

CX Coccyx Cutout \$215

Cloud 9, Revive, Top Shelf & M Plus

D1 No Inflatable Lumbar (\$50)

E ESD* \$290

F Fring® Footrest \$50

Only available on (B0) base

N N-dulgent® Memory Foam \$125

N2 TheraGel™ Memory Foam \$150

Casters/Glides

C1 Hard Floor \$25

C2 Glides \$25

C3 Occupied Braking \$185

C4 Unoccupied Braking \$60

C8 Chrome Carpet \$90

C9 Chrome Hard Floor \$100

Bases

B6 26" Polished Aluminum \$140

Recommended with (L1)

B8 27" Brushed Aluminum \$140

Recommended with (L1)

B12 28" Black \$110

Chair Cylinders

L1 3" Cylinder \$0

L13 7" Dual Stage \$55

L14 10" Dual Stage \$55

Connexion® Arm

Z1 Connexion Arm \$350

Only available on (5) & (6) seat

Connexion® Arm Attachments

A1 Tablet Holder \$149

Requires (Z1) Connexion Arm

Stool Options

Stool Cylinders

L4 8" Cylinder \$55

L5 10" Cylinder \$55

L7 7" Cylinder \$55

Footrings for stool cylinders only

R1 18" Black Plastic \$60

R2 20" Chrome \$80

NeXtep® for stool cylinders only

R8 8" w/Casters \$185

R10 10" w/Casters \$185

R18 8"/10" w/Casters \$295

RW8 Wide 8" w/Casters \$295

RW10 Wide 10" w/Casters \$295

Also available w/glides.

For additional stool options see page 110.

6000 Series

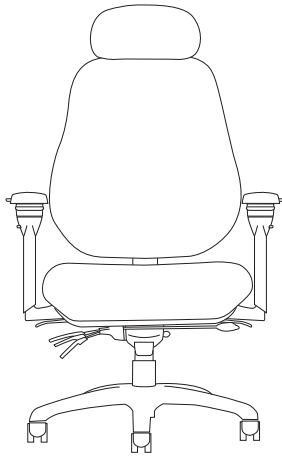

NPS6800-H4

Features

- Up to 15 active adjustments
- High back & contoured seat designs
- Passive weight dispersion design
- Generous foam for optimal comfort
- Inflatable lumbar
- Optional headrest

Standard Features

- 5-way 360° Arms
- Carpet Casters
- 26" Black Base
- 5" Cylinder
- Seat Slider

Need it Now? 5-day Quick Ship

Only standard features are available as Quick Ship unless otherwise noted.

QUICK SHIP ARMS

- 0 5-way 360°
- 5 No Arms

QUICK SHIP FABRICS

For available Quick Ship fabrics see page 8.

Step 1 — Model Number

Series Code	Back	Select a Seat	Select an Arm	Mech
NPS Neutral Posture Series	6 High Back	5 Medium Seat, Minimal Contour 6 Medium Seat, Moderate Contour 7 Medium Seat, Deep Contour 8 Large Seat, Minimal Contour 9 Large Seat, Deep Contour	0 5-way 360° \$0 3 360° w/Oversized Urethane \$75 4 Swing \$155 5 No Arms (\$140) 6 360° w/Oversized Black Vinyl \$225 7 360° w/Oversized Fabric/Leather \$265 P 360° Swivel \$0	0 Multi-function \$0 
NPS	6	8	0	0



NPS6500	NPS6600	NPS6700	NPS6800	NPS6900
\$1,472	\$1,539	\$1,550	\$1,550	\$1,586
\$1,532	\$1,599	\$1,610	\$1,610	\$1,646
\$1,592	\$1,659	\$1,670	\$1,670	\$1,706
\$1,662	\$1,729	\$1,740	\$1,740	\$1,776
\$1,732	\$1,799	\$1,810	\$1,810	\$1,846
\$1,812	\$1,879	\$1,890	\$1,890	\$1,926
\$1,892	\$1,959	\$1,970	\$1,970	\$2,006
\$1,982	\$2,049	\$2,060	\$2,060	\$2,096
\$2,072	\$2,139	\$2,150	\$2,150	\$2,186

42 x 26 x 26	42 x 26 x 26	42 x 26 x 26	42 x 26 x 26	42 x 26 x 26
63 lbs	63 lbs	67.5 lbs	67.5 lbs	67.5 lbs
21	23	23	23	25
17.5 – 22.5	17.5 – 22.5	17.5 – 22.5	18.25 – 23.25	17.5 – 22.5
15 – 17.5	15 – 17.5	16 – 18.5	18 – 20.5	19.5 – 22
F3° – R11°	F9° – R6°	F10° – R3°	F5° – R7°	F8° – R6°
22.5	22.5	22.5	22.5	22.5
21.5 – 25.5	21.5 – 25.5	22 – 26	22.5 – 26.5	22 – 26
97° – 112°	98° – 113°	97° – 113°	99° – 114°	99° – 115°
4	4	4	4	4
7 – 11	7 – 11	7 – 11	6.5 – 10.5	6.5 – 10.5
15.75 – 22.25	15.75 – 22.25	18 – 22.25	18 – 22.25	18.5 – 22.25
26	26	26	26	26
2.5 yd	2.5 yd	2.5 yd	2.5 yd	2.5 yd
28 x 26 x 24	28 x 26 x 24	28 x 26 x 24	28 x 26 x 24	37 x 30 x 52
73 lbs	73 lbs	77.5 lbs	77.5 lbs	77.5 lbs
KD	KD	KD	KD	FA

- Grade 1
- Grade 2
- Grade 3
- Grade 4
- Grade 5
- Grade 6
- Grade 7
- Grade 8
- Grade 9

Upholstered Back Outer		
U1	Grade 1	\$120
U2	Grade 2	\$140
U3	Grade 3	\$160
U4	Grade 4	\$180
U5	Grade 5	\$200
U6	Grade 6	\$220
U7	Grade 7	\$240
U8	Grade 8	\$260
U9	Grade 9	\$280

- Chair (H x W x D)
- Chair Weight
- Seat Width
- Seat Height
- Seat Depth
- Seat Angle
- Back Width
- Back Height
- Back Angle
- Lumbar Range
- Arm Height
- Arm Width
- Base Diameter
- COM Yardage
- Shipping Box (L x W x H)
- Shipping Weight
- Shipping Method

All measurements are nominal and shown in inches.

Step 2 — Add option codes after model number NPS6800 - _ - _

Continuous Shift Warranty	Finishes	Casters/Glides	Cylinders
IU Continuous-shift warranty \$290	PT Pillow Top \$860 <i>Only available on (8) seat; Only in Canter, Ultraleather™ or leather</i>	C1 Hard Floor \$25	L1 3" Cylinder \$0
General	SL Stitched Leather \$350 <i>Not available on (7) & (9) seat; Only in Ultraleather™ or leather</i>	C2 Glides \$25	L13 7" Dual Stage \$55
A Thoracic Support \$80		C3 Occupied Braking \$185	L14 10" Dual Stage \$55
CR Cleanroom to Class 100 \$120		C4 Unoccupied Braking \$60	Headrest
CX Coccyx Cutout \$215 <i>Cloud 9, Revive, Top Shelf & M Plus</i>		C8 Chrome Carpet \$90	H4 Dual Pivot \$280 <i>Matching upholstery</i>
E ESD* \$290		C9 Chrome Hard Floor \$100	Connexion® Arm
F Fring® Footrest \$50 <i>Only available on (B0) base</i>		Bases	Z1 Connexion Arm \$350 <i>Only available on (5) & (6) seat</i>
N N-dulgent® Memory Foam \$125		B6 26" Polished Aluminum \$140 <i>Recommended with (L1)</i>	Connexion® Arm Attachments
N2 TheraGel™ Memory Foam \$150		B8 27" Brushed Aluminum \$140 <i>Recommended with (L1)</i>	A1 Tablet Holder \$149 <i>Requires (Z1) Connexion Arm</i>
		B12 28" Black \$110	

* Contact Customer Service – customerservice@neutralposture.com

8000 Series

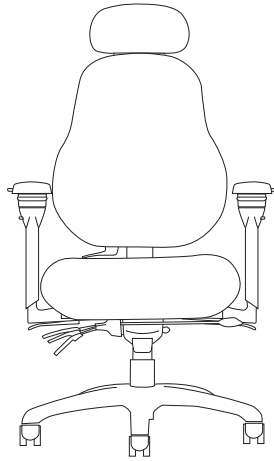

NPS8500-H4

Features

- Up to 15 active adjustments
- High back & contoured seat designs
- Passive weight dispersion design
- Generous foam for optimal comfort
- Inflatable lumbar
- Optional headrest

Standard Features

- 5-way 360° Arms
- Carpet Casters
- 26" Black Base
- 5" Cylinder
- Seat Slider

Need it Now? 5-day Quick Ship

Only standard features are available as Quick Ship unless otherwise noted.

QUICK SHIP ARMS

- 0 5-way 360°
- 5 No Arms

QUICK SHIP FABRICS

For available Quick Ship fabrics see page 8.

Step 1 — Model Number

Series Code	Back	Select a Seat	Select an Arm	Mech
NPS Neutral Posture Series	8 High Back	<ul style="list-style-type: none"> 5 Medium Seat, Minimal Contour 6 Medium Seat, Moderate Contour 7 Medium Seat, Deep Contour 8 Large Seat, Minimal Contour 9 Large Seat, Deep Contour 	<ul style="list-style-type: none"> 0 5-way 360° \$0 3 360° w/Oversized Urethane \$75 4 Swing \$155 5 No Arms (\$140) 6 360° w/Oversized Black Vinyl \$225 7 360° w/Oversized Fabric/Leather \$265 P 360° Swivel \$0 	<ul style="list-style-type: none"> 0 Multi-function \$0 
NPS	8	5	0	0

Extra Tall				
NPS8500	NPS8600	NPS8700	NPS8800	NPS8900
\$1,420	\$1,487	\$1,498	\$1,498	\$1,534
\$1,480	\$1,547	\$1,558	\$1,558	\$1,594
\$1,540	\$1,607	\$1,618	\$1,618	\$1,654
\$1,610	\$1,677	\$1,688	\$1,688	\$1,724
\$1,680	\$1,747	\$1,758	\$1,758	\$1,794
\$1,760	\$1,827	\$1,838	\$1,838	\$1,874
\$1,840	\$1,907	\$1,918	\$1,918	\$1,954
\$1,930	\$1,997	\$2,008	\$2,008	\$2,044
\$2,020	\$2,087	\$2,098	\$2,098	\$2,134

40 x 26 x 26	40 x 26 x 26	40 x 26 x 26	40 x 26 x 26	40 x 26 x 26
59.5 lbs	61 lbs	65 lbs	65 lbs	65 lbs
21	23	23	23	25
17.5 – 22.5	17.5 – 22.5	17.5 – 22.5	18.25 – 23.25	17.5 – 22.5
15.5 – 18	16 – 18.5	16 – 18.5	18 – 20.5	19 – 21.5
F3° – R11°	F9° – R6°	F10° – R3°	F5° – R7°	F8° – R6°
19.5	19.5	19.5	19.5	19.5
21.5 – 25.5	22 – 26	22 – 26	22.5 – 26.5	22 – 26
100° – 119°	100° – 115°	100° – 115°	100° – 121°	100° – 116°
4	4	4	4	4
7 – 11	7 – 11	7 – 11	6.5 – 10.5	6.5 – 10.5
15.75 – 22.25	15.75 – 22.25	18 – 22.25	18 – 22.25	18.5 – 22.25
26	26	26	26	26
2 yd	2 yd	2 yd	2 yd	2 yd
28 x 26 x 24	28 x 26 x 24	28 x 26 x 24	28 x 26 x 24	37 x 30 x 52
69.5 lbs	71 lbs	75 lbs	75 lbs	75 lbs
KD	KD	KD	KD	FA

All measurements are nominal and shown in inches. Specs may differ for stools.

- Grade 1
- Grade 2
- Grade 3
- Grade 4
- Grade 5
- Grade 6
- Grade 7
- Grade 8
- Grade 9

- Chair (H x W x D)
- Chair Weight
- Seat Width
- Seat Height
- Seat Depth
- Seat Angle
- Back Width
- Back Height
- Back Angle
- Lumbar Range
- Arm Height
- Arm Width
- Base Diameter
- COM Yardage
- Shipping Box (L x W x H)
- Shipping Weight
- Shipping Method

Upholstered Back Outer		
U1	Grade 1	\$120
U2	Grade 2	\$140
U3	Grade 3	\$160
U4	Grade 4	\$180
U5	Grade 5	\$200
U6	Grade 6	\$220
U7	Grade 7	\$240
U8	Grade 8	\$260
U9	Grade 9	\$280

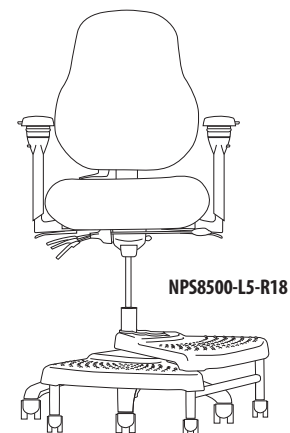

Step 2 — Add option codes after model number NPS8500 - __ - __

Continuous Shift Warranty

IU Continuous-shift warranty \$290

General

A Thoracic Support \$80

CR Cleanroom to Class 100 \$120

CX Coccyx Cutout \$215

Cloud 9, Revive, Top Shelf & M Plus

D1 No Inflatable Lumbar (\$50)

E ESD* \$290

F Fring® Footrest \$50

Only available on (B0) base

N N-dulgent® Memory Foam \$125

N2 TheraGel™ Memory Foam \$150

Finishes

SL Stitched Leather \$350

*Not available on (7) or (9) seat;
Only in Ultraleather™ or leather*

Casters/Glides

C1 Hard Floor \$25

C2 Glides \$25

C3 Occupied Braking \$185

C4 Unoccupied Braking \$60

C8 Chrome Carpet \$90

C9 Chrome Hard Floor \$100

Bases

B6 26" Polished Aluminum \$140

Recommended with (L1)

B8 27" Brushed Aluminum \$140

Recommended with (L1)

B12 28" Black \$110

Cylinders

L1 3" Cylinder \$0

L13 7" Dual Stage \$55

L14 10" Dual Stage \$55

Headrest

H4 Dual Pivot \$280

Matching upholstery

Connexion® Arm

Z1 Connexion Arm \$350

Only available on (5) & (6) seat

Connexion® Arm Attachments

A1 Tablet Holder \$149

Requires (Z1) Connexion Arm

Stool Options

Stool Cylinders

L4 8" Cylinder \$55

L5 10" Cylinder \$55

L7 7" Cylinder \$55

Footrings for stool cylinders only

R1 18" Black Plastic \$60

R2 20" Chrome \$80

NeXtep® for stool cylinders only

R8 8" w/Casters \$185

R10 10" w/Casters \$185

R18 8"/10" w/Casters \$295

RW8 Wide 8" w/Casters \$295

RW10 Wide 10" w/Casters \$295

Also available w/glides.

For additional stool options see page 110.

8000 Series

Tall & Skinny

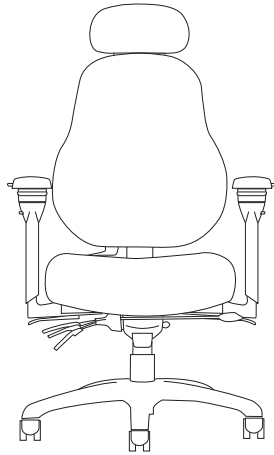

NPS8200-H4

Features

- Up to 15 active adjustments
- High back & extra deep seat
- Passive weight dispersion design
- Generous foam for optimal comfort
- Inflatable lumbar
- Optional headrest

Standard Features

- 5-way 360° Arms
- Carpet Casters
- 28" Intensive Use Black Base
- 5" Cylinder
- Seat Slider

Step 1 — Model Number

Series Code	Back	Select a Seat	Select an Arm	Mech
NPS Neutral Posture Series	8 High Back	2 Extra Deep Seat <i>Minimal Contour</i>	0 5-way 360° \$0 3 360° w/Oversized Urethane \$75 4 Swing \$155 5 No Arms (\$140) 6 360° w/Oversized Black Vinyl \$225 7 360° w/Oversized Fabric/Leather \$265 P 360° Swivel \$0	0 Multi-function 
NPS	8	2	0	0



NPS8200

\$1,648	Grade 1
\$1,708	Grade 2
\$1,768	Grade 3
\$1,838	Grade 4
\$1,908	Grade 5
\$1,988	Grade 6
\$2,068	Grade 7
\$2,158	Grade 8
\$2,248	Grade 9

Upholstered Back Outer		
U1	Grade 1	\$120
U2	Grade 2	\$140
U3	Grade 3	\$160
U4	Grade 4	\$180
U5	Grade 5	\$200
U6	Grade 6	\$220
U7	Grade 7	\$240
U8	Grade 8	\$260
U9	Grade 9	\$280

43 x 28 x 28	Chair (H x W x D)
57 lbs	Chair Weight
20	Seat Width
18.75 – 23.75	Seat Height
20.5 – 23	Seat Depth
F7° – R8°	Seat Angle
19.5	Back Width
21.5 – 25.5	Back Height
100° – 119°	Back Angle
4	Lumbar Range
7 – 11	Arm Height
15.75 – 22.25	Arm Width
28	Base Diameter
2 yd	COM Yardage
28 x 26 x 24	Shipping Box (L x W x H)
67 lbs	Shipping Weight
KD	Shipping Method

All measurements are nominal and shown in inches.

Step 2 — Add option codes after model number NPS8200 - ___ - ___

General		Casters/Glides		Cylinders		Headrest					
A	Thoracic Support	\$80	C1	Hard Floor	\$25	L1	3" Cylinder	\$0	H4	Dual Pivot	\$280
CR	Cleanroom to Class 100	\$120	C2	Glides	\$25	L7	7" Cylinder	\$55		<i>Matching upholstery</i>	
D1	No Inflatable Lumbar	(\$50)				L13	7" Dual Stage	\$55			
N	N-dulgent® Memory Foam	\$125									
N2	TheraGel™ Memory Foam	\$150									

Big & Tall

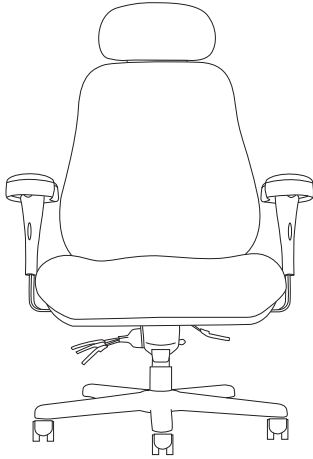

BTC10100-H4



BTC16800
Extra Tall

Features

- Up to 11 active adjustments
- High back & contoured seat designs
- 24/7 Continuous-shift 5-year warranty only available on upholstery with a double rub rating of over 1,000,000
- Available in both regular & junior sizes
- Supports users up to 500 lbs and/or 7 ft tall
- Inflatable lumbar
- Optional headrest
- Optional leather pillow top

Standard Features

- Oversized Padded Arms
- Carpet Casters
- 28" Intensive Use Black Base
- 5" Cylinder
- Seat Slider

Need it Now? 5-day Quick Ship

Only standard features are available as Quick Ship unless otherwise noted.

QUICK SHIP ARMS

- 0 Oversized Padded
- 1 Urethane Arm Pads

QUICK SHIP FABRICS

For available Quick Ship fabrics see page 8.

Step 1 — Model Number

Series Code	Select a Back	Select a Seat	Select an Arm	Mech
BTC Big & Tall	16 High Back 10 Extra Large Back	1 Extra Large Seat, Minimal Contour 8 Large Seat, Minimal Contour 9 Large Seat, Deep Contour	0 Oversized Padded \$0 1 Urethane Arm Pads (\$50)	0 Multi-function 
BTC	10	1	0	0



Regular	Junior (Extra Tall)	
BTC10100	BTC16800	BTC16900
\$2,236	\$2,236	\$2,272
\$2,296	\$2,296	\$2,332
\$2,356	\$2,356	\$2,392
\$2,426	\$2,426	\$2,462
\$2,496	\$2,496	\$2,532
\$2,576	\$2,576	\$2,612
\$2,656	\$2,656	\$2,692
\$2,746	\$2,746	\$2,782
\$2,836	\$2,836	\$2,872

42 x 35 x 28	41 x 31 x 28	41 x 31 x 28
85 lbs	76 lbs	76 lbs
27	23	25
20 – 25	19 – 24	19 – 24
20 – 22	19 – 21	20 – 22
F1° – R7.5°	F4° – R12°	F1° – R9°
24	22.5	22.5
22 – 26	22 – 26	24 – 28
96° – 118°	95° – 112°	97° – 115°
4	4	4
7 – 10	7 – 10	7 – 10
24	21	24
28	28	28
2.5 yd	2.5 yd	2.5 yd
37 x 30 x 52	37 x 30 x 52	37 x 30 x 52
105 lbs	96 lbs	96 lbs
FA	FA	FA

All measurements are nominal and shown in inches.

- Grade 1
- Grade 2
- Grade 3
- Grade 4
- Grade 5
- Grade 6
- Grade 7
- Grade 8
- Grade 9

- Chair (H x W x D)
- Chair Weight
- Seat Width
- Seat Height
- Seat Depth
- Seat Angle
- Back Width
- Back Height
- Back Angle
- Lumbar Range
- Arm Height
- Arm Width
- Base Diameter
- COM Yardage
- Shipping Box (L x W x H)
- Shipping Weight
- Shipping Method

Upholstered Back Outer		
U1	Grade 1	\$120
U2	Grade 2	\$140
U3	Grade 3	\$160
U4	Grade 4	\$180
U5	Grade 5	\$200
U6	Grade 6	\$220
U7	Grade 7	\$240
U8	Grade 8	\$260
U9	Grade 9	\$280

Step 2 — Add option codes after model number BTC10100 - _ - _

General	Finishes	Bases	Headrest
A Thoracic Support \$80	PT Pillow Top \$1,000	B9 28" Chrome \$160	H4 Dual Pivot \$280
CR Cleanroom to Class 100 \$120	<i>Only available on (1) & (8) seat; only in Canter, Ultraleather™ or leather</i>		<i>Matching upholstery</i>
CX Coccyx Cutout \$215			
<i>Cloud 9, Revive, Top Shelf & M Plus</i>			
E ESD* \$290			
<i>Arms are fixed when ESD added</i>			
J Upholstered Arm Pad \$65			
<i>Only available on (0) arm</i>			
N N-dulgent® Memory Foam \$125			
N2 TheraGel™ Memory Foam \$150			
	Casters/Glides	Cylinders	
	C1 Hard Floor \$25	L1 3" Cylinder \$0	
	C2 Glides \$25		

* Contact Customer Service – customerservice@neutralposture.com

XSM™
Extra Small

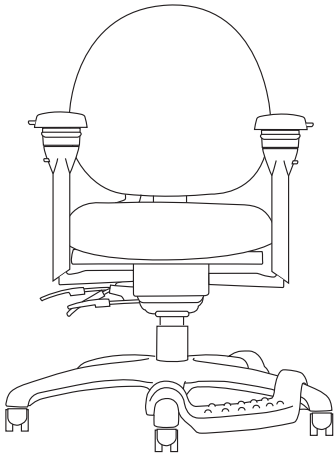

XSM5300-F

Features

- Up to 15 active adjustments
- Petite seat
- Mesh back, mid back or high back
- Passive weight dispersion design
- Generous foam for optimal comfort
- Inflatable lumbar on 5 & 8 back
- Optional headrest available on 1 & 8 back

Standard Features

- 5-way 360° Arms
- Carpet Casters
- 26" Black Base
- 5" Cylinder
- Seat Slider

Need it Now? 5-day Quick Ship

Only standard features are available as Quick Ship unless otherwise noted.

QUICK SHIP ARMS

- 0 5-way 360°
- 5 No Arms

QUICK SHIP FABRICS

For available Quick Ship fabrics see page 8.

Step 1 — Model Number

Series Code	Select a Back	Select a Seat	Select an Arm	Mech
XSM Extra Small Series	<ul style="list-style-type: none"> 1 Mesh Back 5 Mid Back 8 High Back 	<ul style="list-style-type: none"> 3 Petite Seat, Minimal Contour 	<ul style="list-style-type: none"> 0 5-way 360° \$0 3 360° w/Oversized Urethane \$75 5 No Arms (\$140) 6 360° w/Oversized Black Vinyl \$225 7 360° w/Oversized Fabric/Leather \$265 P 360° Swivel \$0 	<ul style="list-style-type: none"> 0 Multi-function 
XSM	5	3	0	0



XSM1300



XSM5300



XSM8300

\$1,305	\$1,352	\$1,487
\$1,365	\$1,412	\$1,547
\$1,425	\$1,472	\$1,607
\$1,495	\$1,542	\$1,677
\$1,565	\$1,612	\$1,747
\$1,645	\$1,692	\$1,827
\$1,725	\$1,772	\$1,907
\$1,815	\$1,862	\$1,997
\$1,905	\$1,952	\$2,087

- Grade 1**
- Grade 2**
- Grade 3**
- Grade 4**
- Grade 5**
- Grade 6**
- Grade 7**
- Grade 8**
- Grade 9**

39.75 x 26 x 26	35.5 x 26 x 26	40.25 x 26 x 26
52.5 lbs	52 lbs	54.5 lbs
17	17	17
15.75 – 20.75	15.75 – 20.75	15.75 – 20.75
15.5 – 18	15.5 – 18	15.5 – 18
F4° – R11°	F4° – R11°	F6° – R12°
19	17.5	19.5
23	18 – 22	23 – 27
95° – 115°	105° – 121°	95° – 111°
3	4	4
7 – 11	7 – 11	7 – 11
13.5 – 18.25	13.5 – 18.25	13.5 – 18.25
26	26	26
1 yd	2 yd	2 yd
28 x 26 x 24	28 x 26 x 24	28 x 26 x 24
62.5 lbs	62 lbs	64.5 lbs
KD	KD	KD

- Chair (H x W x D)
- Chair Weight
- Seat Width
- Seat Height
- Seat Depth
- Seat Angle
- Back Width
- Back Height
- Back Angle
- Lumbar Range
- Arm Height
- Arm Width
- Base Diameter
- COM Yardage
- Shipping Box (L x W x H)
- Shipping Weight
- Shipping Method

All measurements are nominal and shown in inches. Specs may differ for stools.

Upholstered Back Outer		
U1	Grade 1	\$120
U2	Grade 2	\$140
U3	Grade 3	\$160
U4	Grade 4	\$180
U5	Grade 5	\$200
U6	Grade 6	\$220
U7	Grade 7	\$240
U8	Grade 8	\$260
U9	Grade 9	\$280

Only available on (5) or (8) back

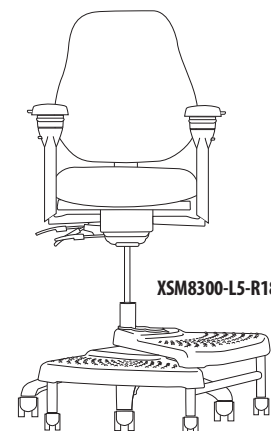

XSM8300-L5-R18

Step 2 — Add option codes after model number XSM5300 - _ - _

General		Back Sleeve – Back of sleeve made w/Spacer	
A	Thoracic Support <i>Not available on (1) back</i>	\$80	
CR	Cleanroom to Class 100	\$120	
CX	Coccyx Cutout <i>Cloud 9, Revive, Top Shelf & M Plus</i>	\$215	
D1	No Inflatable Lumbar	(\$50)	
E	ESD*	\$290	
F	Fring® Footrest <i>Only available on (B0) base</i>	\$50	
N	N-dulgent® Memory Foam	\$125	
N2	TheraGel™ Memory Foam	\$150	
Only available on (1) back			
Headrests		Chair Cylinders	
HE	Height Adjustable <i>Black vinyl – (1) back only</i>	\$60	
H4	Dual Pivot <i>Matching upholstery – (8) back only</i>	\$280	
H5	Dual Pivot <i>Black faux leather – (1) back only</i>	\$280	
S1	Grade 1	\$110	
S2	Grade 2	\$160	
S3	Grade 3	\$200	
S4	Grade 4	\$240	
S5	Grade 5	\$280	
S6	Grade 6	\$330	
S7	Grade 7	\$380	
S8	Grade 8	\$430	
S9	Grade 9	\$480	

Casters/Glides		
C1	Hard Floor	\$25
C2	Glides	\$25
C3	Occupied Braking	\$185
C4	Unoccupied Braking	\$60
C8	Chrome Carpet	\$90
C9	Chrome Hard Floor	\$100
Bases		
B6	26" Polished Aluminum <i>Recommended with (L1)</i>	\$140
B8	27" Brushed Aluminum <i>Recommended with (L1)</i>	\$140
B12	28" Black	\$110

Stool Options

Stool Cylinders		
L4	8" Cylinder	\$55
L5	10" Cylinder	\$55
L7	7" Cylinder	\$55
Footrings – for stool cylinders only		
R1	18" Black Plastic	\$60
R2	20" Chrome	\$80
NeXtep® – for stool cylinders only		
R8	8" w/Casters	\$185
R10	10" w/Casters	\$185
R18	8"/10" w/Casters	\$295
RW8	Wide 8" w/Casters	\$295
RW10	Wide 10" w/Casters	\$295

Also available w/glides.

For additional stool options see page 110.

* Contact Customer Service – customerservice@neutralposture.com

TASK/CONFERENCE SEATING

Neutral Posture's task/conference seating offers a wide range of styles, features and options to address any application needs. The task/conference seating was designed with elegance and engineered with functionality and health promoting benefits in mind. The task/conference seating is also a very broad category, providing anything from highly ergonomic chairs for personal use to stools and guest chairs for shorter periods of seated time and unique tasks. The multitude of specialty armrests and fabric types available will ensure that you have the chair needed to complete the task at hand and

look good while doing it. In our task/conference seating we have many different families of chairs, allowing you to fill your space with multi-functional chairs having a common theme and look. We offer many of our task/conference chairs in mesh making the chair more breathable for comfort, as well as providing a customizable sleeve that you can slide over the mesh back for an upholstered look and feel. Whether you are in the market to find an ergonomic chair to boost comfort and productivity or a family of chairs to spice up the office, our task/conference seating has the exact chair to fit your wants and needs.

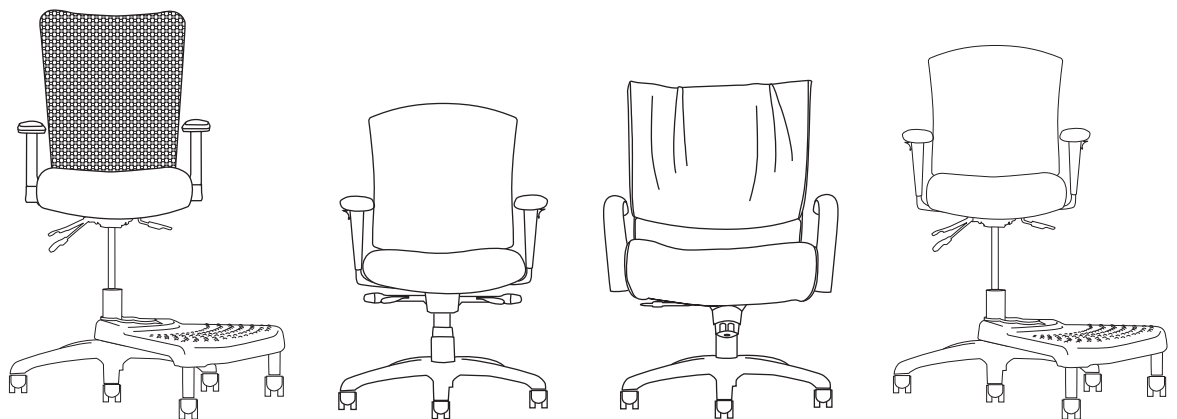

TASK/CONFERENCE SEATING

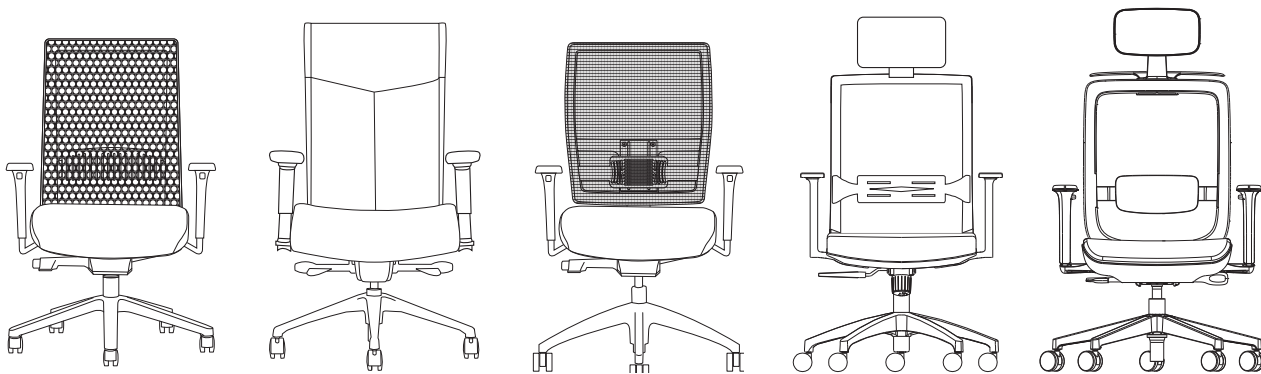

Arm Options

Standard Arms

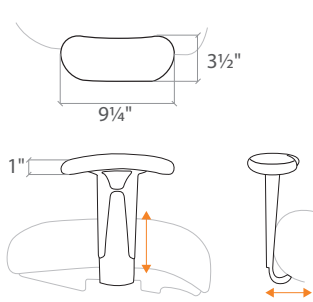

0 4" ADJUSTABLE

Arm Height	7.0 – 11.0
Arm Width	17.5 – 21.5
Arm Pivot	fixed
Weight	7 lbs

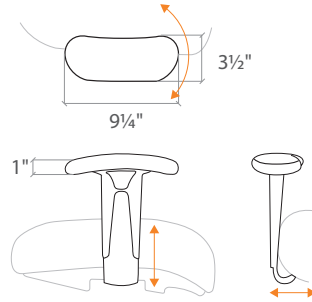

1 4" ADJ. W/PIVOT

Arm Height	7.0 – 11.0
Arm Width	17.5 – 21.5
Arm Pivot	25° range
Weight	7 lbs

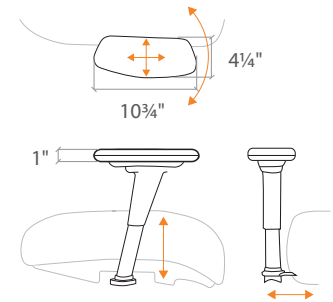

2 LATERAL SLIDING

Arm Height	7.0 – 11.0
Arm Width	17.5 – 21.5
Arm Pivot	30° range
Weight	7 lbs

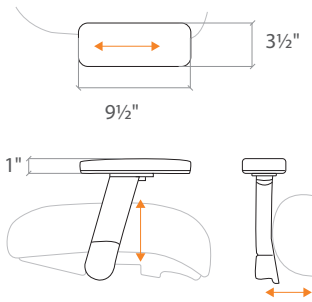

3 3" ADJUSTABLE

Arm Height	7.5 – 11.0
Arm Width	18.0 – 24.0
Arm Pivot	fixed
Weight	6 lbs

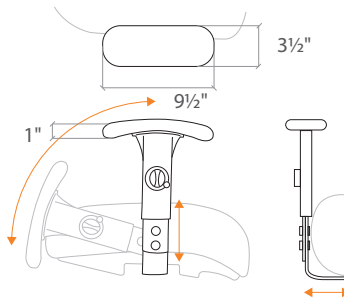

4 SWING

Arm Height	7.0 – 10.0
Arm Width	17.75 – 22.0
Arm Pivot	fixed
Weight	7 lbs

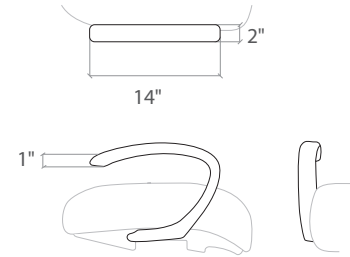

6 CLOOP

Arm Height	7.5
Arm Width	22.5
Arm Pivot	fixed
Weight	5 lbs

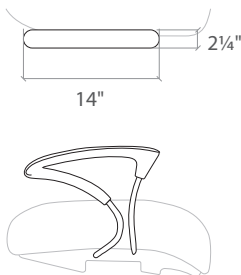

7 CHROME LOOP

Arm Height	7.5
Arm Width	22.25
Arm Pivot	fixed
Weight	5 lbs

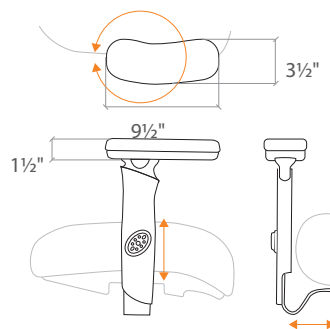

8 360° NP

Arm Height	7.0 – 11.0
Arm Width	18 – 22
Arm Pivot	360° range
Weight	7 lbs

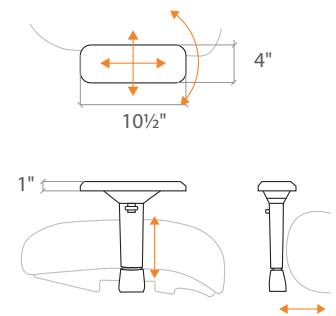

9 5-WAY ADJUSTABLE

Arm Height	7.0 – 10.0
Arm Width	16.5 – 23.5
Arm Pivot	15° range
Weight	6 lbs

Task/Conference

Arm Options

Knomi and Ulius Arms

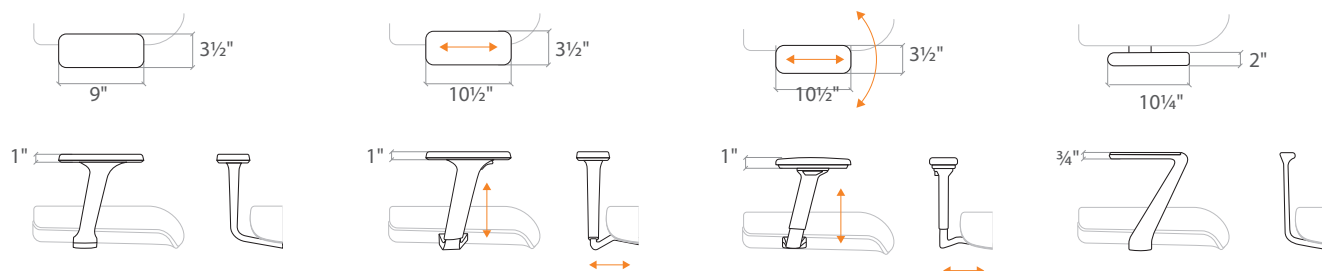

0 FIXED

Arm Height 7
Arm Width 19.75
Arm Pivot fixed
Weight 4 lbs

3 3D

Arm Height 6 – 9
Arm Width 18 – 20.5
Arm Pivot fixed
Weight 4 lbs

4 4D

Arm Height 6 – 9
Arm Width 18 – 20.5
Arm Pivot 30° range
Weight 4 lbs

7 CHROME LOOP

Arm Height 9
Arm Width 20.5
Arm Pivot fixed
Weight 6 lbs

Icon Arms

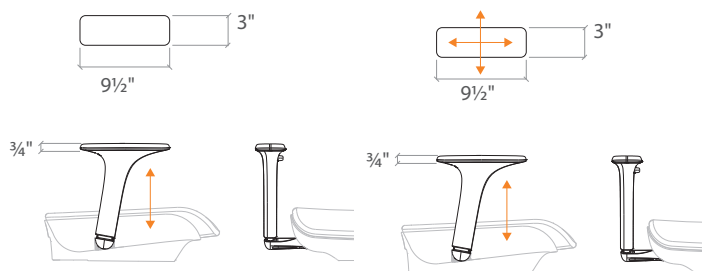

0 1D

Arm Height 7 – 10.5
Arm Width 19.5
Arm Pivot fixed
Weight 4.5 lbs

3 3D

Arm Height 7 – 10.5
Arm Width 18.0 – 20.0
Arm Pivot fixed
Weight 4.5 lbs

Renati Arms

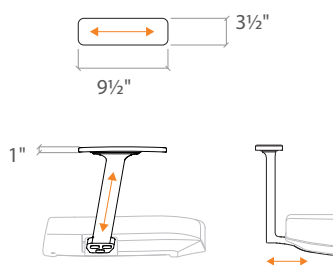

0 ADJUSTABLE

Arm Height 7.0 – 11.0
Arm Width 18.5 – 19.5
Arm Pivot fixed
Weight 4 lbs

Balance Arms

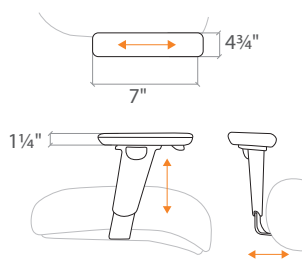

1 FORWARD SLIDING GELTHANE

Arm Height 7 – 10
Arm Width 19 – 23
Arm Pivot fixed
Weight 4.5 lbs

All measurements are nominal and shown in inches.

CHAIR MECHANISMS

Task/Conference



0 KNEE-TILT

- Swivel 360°
- Pneumatic seat height
- Seat tilt tension
- Back to seat tilt, 1:1
- Rock or lock recline

Available on

Balance
Embrace



2 SYNCHRO

- Swivel 360°
- Pneumatic seat height
- Seat tilt tension
- Back angle
- Seat angle
- Back to seat tilt, 2:1
- Anti-kick tilt-lock
- Optional seat slider

Available on

Balance
Cozi
NV
Right Chair
U4ia

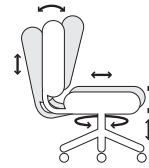

3 WEIGHT SENSITIVE

- Swivel 360°
- Pneumatic seat height
- Seat tilt tension
- Back angle
- Seat angle
- Back to seat tilt, 2:1
- Anti-kick tilt-lock
- Seat slider

Available on

Icon



4 TILT-SWIVEL

- Swivel 360°
- Pneumatic seat height
- Seat tilt tension
- Back to seat tilt, 1:1

Available on

Embrace
Renati



6 MULTI-TILT

- Swivel 360°
- Pneumatic seat height
- Independent back angle
- Independent seat angle
- Seat tilt tension
- Infinite adjust forward tilt-stop
- Optional seat slider

Available on

Cozi
E-Series
Right Chair

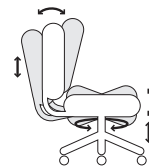

8 MULTI-TILT

- Swivel 360°
- Pneumatic seat height
- Independent back angle
- Independent seat angle
- Seat tilt tension
- Infinite adjust forward tilt-stop
- Seat slider

Available on

Cozi 24/7

CHAIR MECHANISMS (Ulius & Knomi)

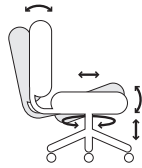

2 SYNCHRO

- Swivel 360°
- Pneumatic seat height
- Quick adjust seat tilt tension
- Back angle
- Seat angle
- Back to seat tilt, 2:1
- Adjustable anti-kick tilt-lock
- Seat slider

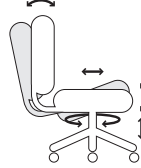

3 WEIGHT SENSITIVE

- Swivel 360°
- Pneumatic seat height
- Weight activated seat tilt tension
- Back angle
- Seat angle
- Back to seat tilt, 2:1
- Adjustable anti-kick tilt-lock
- Seat slider

STOOL MECHANISMS

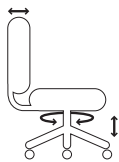

1 BASIC

- Swivel 360°
- Pneumatic seat height
- Back depth

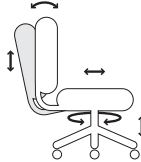

8 STANDARD

- Swivel 360°
- Pneumatic seat height
- Seat slider
- Independent back angle

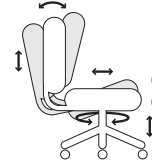

9 DELUXE-TILT

- Swivel 360°
- Pneumatic seat height
- Seat slider
- Seat angle
- Independent back angle

Available on

Cozi Stool
Right Chair Stool
U4ia Stool

Available on

Cozi Stool
Right Chair Stool
U4ia Stool

Available on

Cozi Stool
Right Chair Stool
U4ia Stool

Headrest Options

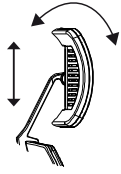

H HEADREST
Matching Upholstery

- Height
- Angle

Available on
Renati

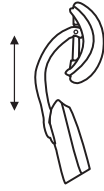

HE SYNCHRO
Black Vinyl

- Height

Available on
Right Chair
Right Chair Stool

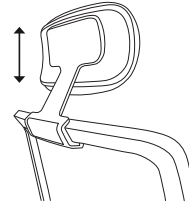

H1 HEADREST
Matching Upholstery

- Height

Available on
Icon

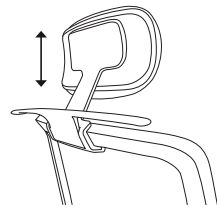

H2 HEADREST W/COAT HANGER
Matching Upholstery

- Height
- Built-in coat hanger

Available on
Icon

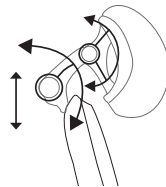

H5 DUAL PIVOT
Black Faux Leather

- Height
- Depth
- 2 pivot points

Available on
Right Chair
Right Chair Stool

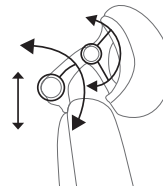

H6 DUAL PIVOT
Matching Upholstery

- Height
- Depth
- 2 pivot points

Available on
Cozi
Cozi 24/7
Cozi Stool



CONNEXION® ARM

THE ONLY GENUINE ERGONOMIC SOLUTION FOR THOSE WHO WORK INTENSELY WITH THEIR TABLET

FEATURES

- Quickly and easily position your tablet where it's comfortable for you
- Holds your tablet so you don't have to
- Eliminates awkward postures and helps reduce upper body fatigue
- Engineered for ease of use
- Can be used while sitting or standing
- 3 mounting options, left, right or both

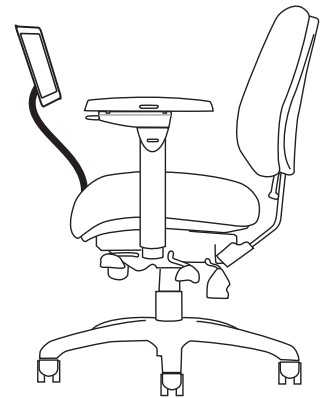
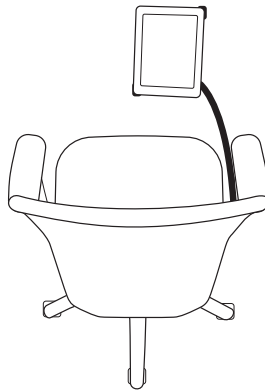
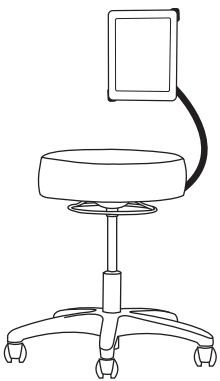

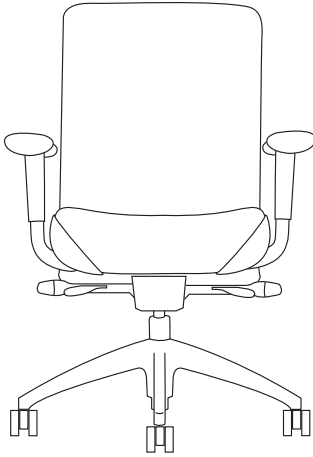

BAL5312

Features

- Up to 11 active adjustments
- Mesh or upholstered back
- Passive weight dispersion design
- Generous foam for optimal comfort

Standard Options

- No Arms
- Carpet Casters
- 26" High Crown Black Base
- 5" Cylinder

Step 1 — Model Number

Series Code	Back	Seat	Select an Arm	Select a Mech
BAL Balance	5 High Back	3 Large Seat	1 Forward Sliding Gelthane Pad \$205 5 No Arms \$0 6 C Loop \$75 7 Chrome Loop \$75	0 Knee-tilt  2 Synchro 
BAL	5	3	1	2

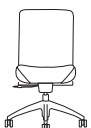
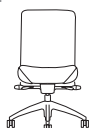
Knee-tilt	Synchro
	
BAL5350	BAL5352
\$1,014	\$1,092
\$1,074	\$1,152
\$1,134	\$1,212
\$1,204	\$1,282
\$1,274	\$1,352
\$1,354	\$1,432
\$1,434	\$1,512
\$1,524	\$1,602
\$1,614	\$1,692

38 x 26 x 26	39 x 26 x 26	Chair (H x W x D)
48.5 lbs	39 lbs	Chair Weight
22	22	Seat Width
16.5 – 21.5	16.5 – 21.5	Seat Height
17.5	16.5 – 19.5	Seat Depth (OPTIONAL)
F6° – R15°	F5° – R12°	Seat Angle
18.5	18.5	Back Width
22	22	Back Height
105° – 125°	102° – 125°	Back Angle
N/A	N/A	Lumbar Range
26	26	Base Diameter
2 yd	2 yd	COM Yardage
26 x 22 x 34	26 x 22 x 34	Shipping Box (L x W x H)
58.5 lbs	49 lbs	Shipping Weight
KD	KD	Shipping Method

All measurements are nominal and shown in inches.
All upholstery subject to Neutral Posture approval.

Step 2 — Add option codes after model number BAL5312-__-__

General		Finishes		Bases		Casters/Glides					
N	N-dulgent® Memory Foam <i>Seat only</i>	\$75	U2	Mesh Back	\$0	B0	26" Black	\$0	C1	Hard Floor	\$25
N2	TheraGel™ Memory Foam <i>Seat only</i>	\$90				B6	26" Polished Aluminum	\$140	C2	Glides	\$25
S	Seat Slider <i>Only available on (2) mech</i>	\$75				B15	26" High Crown Polished Aluminum	\$55	C8	Chrome Carpet	\$90
									C9	Chrome Hard Floor	\$100

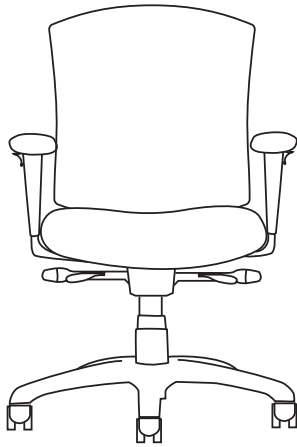

COZ5602

Task/Conference

Features

- Up to 13 active adjustments
- Standard with upholstered back outer
- Passive weight dispersion design
- Generous foam for optimal comfort
- Optional headrest

Standard Features

- No Arms
- Carpet Casters
- 26" Black Base
- 5" Cylinder

Guardian®

The Guardian is an NIJ Level II compliant bullet resistant vest that will provide protection against regular powered 9mm handguns, up to .357 Magnums. The vest fits over the back of the chair and is easily removable.

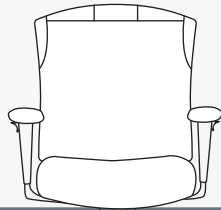

Need it Now? 5-day Quick Ship

Only standard features are available as Quick Ship unless otherwise noted.



QUICK SHIP ARMS







- 3 3" Adjustable Arms
- 5 No Arms
- 9 5-way Adjustable Arms

QUICK SHIP FABRICS

For available Quick Ship fabrics see page 8.

Step 1 — Model Number

Series Code	Select a Back	Select a Seat	Select an Arm	Select a Mech
COZ Cozi	5 Mid Back 6 High Back	6 Medium Seat 7 Large Seat	0 4" Adjustable \$125 1 4" Adjustable w/Pivot \$150 2 Lateral Sliding \$140 3 3" Adjustable \$75 4 Swing \$295 5 No Arms \$0 6 C Loop \$75 7 Chrome Loop \$75 9 5-way Adjustable \$150	2 Synchro  6 Multi-tilt 
COZ	5	6	3	6

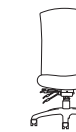
Synchro				Multi-tilt				
								
COZ5652	COZ5752	COZ6652	COZ6752	COZ5656	COZ5756	COZ6656	COZ6756	
\$811	\$862	\$913	\$964	\$887	\$938	\$989	\$1,040	Grade 1
\$871	\$922	\$973	\$1,024	\$947	\$998	\$1,049	\$1,100	Grade 2
\$931	\$982	\$1,033	\$1,084	\$1,007	\$1,058	\$1,109	\$1,160	Grade 3
\$1,001	\$1,052	\$1,103	\$1,154	\$1,077	\$1,128	\$1,179	\$1,230	Grade 4
\$1,071	\$1,122	\$1,173	\$1,224	\$1,147	\$1,198	\$1,249	\$1,300	Grade 5
\$1,151	\$1,202	\$1,253	\$1,304	\$1,227	\$1,278	\$1,329	\$1,380	Grade 6
\$1,231	\$1,282	\$1,333	\$1,384	\$1,307	\$1,358	\$1,409	\$1,460	Grade 7
\$1,321	\$1,372	\$1,423	\$1,474	\$1,397	\$1,448	\$1,499	\$1,550	Grade 8
\$1,411	\$1,462	\$1,513	\$1,564	\$1,487	\$1,538	\$1,589	\$1,640	Grade 9
39 x 26 x 26	39 x 26 x 26	43.5 x 26 x 26	43.5 x 26 x 26	39 x 26 x 26	39 x 26 x 26	43.5 x 26 x 26	43.5 x 26 x 26	Chair (H x W x D)
47 lbs	47 lbs	47 lbs	47 lbs	51 lbs	51 lbs	51 lbs	51 lbs	Chair Weight
19.5	22	19.5	22	19.5	22	19.5	22	Seat Width
16.5 – 21.5	16.5 – 21.5	16.5 – 21.5	16.5 – 21.5	16.5 – 21.5	16.5 – 21.5	16.5 – 21.5	16.5 – 21.5	Seat Height
16.5 – 19.5	16.5 – 19.5	16.5 – 19.5	16.5 – 19.5	16.5 – 19	16.5 – 19	16.5 – 19	16.5 – 19	Seat Depth (OPTIONAL)
F6° – R13°	F6° – R13°	F6° – R13°	F6° – R13°	F6° – R16°	F8° – R18°	F6° – R16°	F8° – R18°	Seat Angle
19	19	19	19	19	19	19	19	Back Width
21 – 24	21 – 24	26 – 29	26 – 29	22 – 25	22 – 25	24 – 27	24 – 27	Back Height
107° – 128°	107° – 128°	107° – 128°	107° – 128°	102° – 122°	102° – 122°	103° – 120°	103° – 120°	Back Angle
3	3	3	3	3	3	3	3	Lumbar Range
26	26	26	26	26	26	26	26	Base Diameter
2 yd	2 yd	2 yd	2 yd	2 yd	2 yd	2 yd	2 yd	COM Yardage
36 x 26 x 19	36 x 26 x 19	36 x 26 x 19	36 x 26 x 19	36 x 26 x 19	36 x 26 x 19	36 x 26 x 19	36 x 26 x 19	Shipping Box (L x W x H)
57 lbs	57 lbs	57 lbs	57 lbs	61 lbs	61 lbs	61 lbs	61 lbs	Shipping Weight
KD	KD	KD	KD	KD	KD	KD	KD	Shipping Method

All measurements are nominal and shown in inches.

Step 2 — Add option codes after model number COZ5636 - _ - _

General	Casters/Glides	Cylinders	Connexion® Arm
CR Cleanroom to Class 100 \$120	C1 Hard Floor \$25	L1 3" Cylinder \$0	Z1 Connexion Arm \$350 <i>Not available with (6) & (7) arm</i>
D2 Adjustable Lumbar Support \$100	C2 Glides \$25	L13 7" Dual Stage \$55	Connexion® Arm Attachments
E ESD* \$290	C3 Occupied Braking \$185	L14 10" Dual Stage \$55	A1 Tablet Holder \$149 <i>Requires (Z1) Connexion Arm</i>
F Fring® Footrest \$50	C4 Unoccupied Braking \$60	Headrest	Guardian – Bullet Resistant Vest
J Upholstered Arm Pad \$65 <i>Only available on (B0) base</i>	Bases	H6 Dual Pivot \$280 <i>Matching upholstery</i>	G Guardian \$1,960 <i>Center or Ballistic Only</i>
N N-dulgent® Memory Foam \$125	B6 26" Polished Aluminum \$140		
N2 TheraGel™ Memory Foam \$150	B7 26" Black Aluminum \$100		
S Seat Slider \$75	B8 27" Brushed Aluminum \$140		

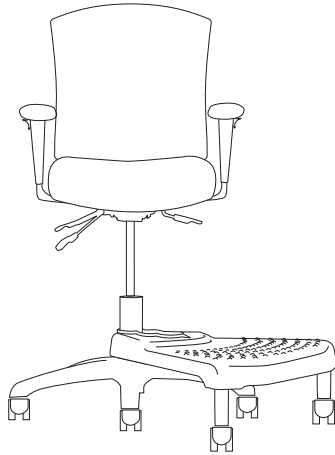

COZ5638-L5-R8

Task/Conference

Features

- Up to 13 active adjustments
- Standard with upholstered back outer
- Passive weight dispersion design
- Generous foam for optimal comfort
- Optional headrest

Standard Features

- No Arms
- Carpet Casters
- 26" Black Base
- 8" Cylinder

Guardian®

The Guardian is an NIJ Level II compliant bullet resistant vest that will provide protection against regular powered 9mm handguns, up to .357 Magnums. The vest fits over the back of the chair and is easily removable.

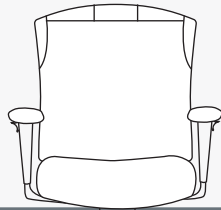

Need it Now? 5-day Quick Ship

Only standard features are available as Quick Ship unless otherwise noted.

QUICK SHIP ARMS







- 3 3" Adjustable Arms
- 5 No Arms
- 9 5-way Adjustable Arms

QUICK SHIP FABRICS

For available Quick Ship fabrics see page 8

Step 1 — Model Number

Series Code	Back	Select a Seat	Select an Arm	Select a Mech
COZ Cozi	5 Mid Back	6 Medium Seat 7 Large Seat	0 4" Adjustable \$125 1 4" Adjustable w/Pivot \$150 2 Lateral Sliding \$140 3 3" Adjustable \$75 4 Swing \$295 5 No Arms \$0 6 C Loop \$75 7 Chrome Loop \$75 9 5-way Adjustable \$150	1 Basic 8 Standard 9 Deluxe-tilt
COZ	5	6	3	8

Basic		Standard		Deluxe-tilt	
					
COZ5651	COZ5751	COZ5658	COZ5758	COZ5659	COZ5759
\$826	\$877	\$847	\$898	\$867	\$918
\$886	\$937	\$907	\$958	\$927	\$978
\$946	\$997	\$967	\$1,018	\$987	\$1,038
\$1,016	\$1,067	\$1,037	\$1,088	\$1,057	\$1,108
\$1,086	\$1,137	\$1,107	\$1,158	\$1,127	\$1,178
\$1,166	\$1,217	\$1,187	\$1,238	\$1,207	\$1,258
\$1,246	\$1,297	\$1,267	\$1,318	\$1,287	\$1,338
\$1,336	\$1,387	\$1,357	\$1,408	\$1,377	\$1,428
\$1,426	\$1,477	\$1,447	\$1,498	\$1,467	\$1,518
43 x 26 x 26	43 x 26 x 26	43.5 x 26 x 26	43.5 x 26 x 26	43.5 x 26 x 26	43.5 x 26 x 26
34 lbs	34 lbs	46 lbs	46 lbs	46 lbs	46 lbs
19.5	22	19.5	22	19.5	22
20.5 – 28.5	20.5 – 28.5	22 – 30	22 – 30	22 – 30	22 – 30
16.5 – 18.5	16.5 – 18.5	16.5 – 19	16.5 – 19	16.5 – 19	16.5 – 19
R4°	R4°	R3°	R3°	R4°	R4°
19	19	19	19	19	19
21.5 – 24	21.5 – 24	22 – 25	22 – 25	22 – 25	22 – 25
103°	103°	95° – 102°	95° – 102°	97° – 105°	97° – 105°
3	3	3	3	3	3
26	26	26	26	26	26
2 yd	2 yd	2 yd	2 yd	2 yd	2 yd
36 x 26 x 19	36 x 26 x 19	36 x 26 x 19	36 x 26 x 19	36 x 26 x 19	36 x 26 x 19
44 lbs	44 lbs	56 lbs	56 lbs	56 lbs	56 lbs
KD	KD	KD	KD	KD	KD

- Grade 1
 - Grade 2
 - Grade 3
 - Grade 4
 - Grade 5
 - Grade 6
 - Grade 7
 - Grade 8
 - Grade 9
- Chair (H x W x D)
 - Chair Weight
 - Seat Width
 - Seat Height
 - Seat Depth (OPTIONAL)
 - Seat Angle
 - Back Width
 - Back Height
 - Back Angle
 - Lumbar Range
 - Base Diameter
 - COM Yardage
 - Shipping Box (L x W x H)
 - Shipping Weight
 - Shipping Method

All measurements are nominal and shown in inches.

Step 2 — Add option codes after model number COZ5638 - _ - _

CR Cleanroom to Class 100 \$120	B6 26" Polished Aluminum \$140	Z1 Connexion Arm \$350 <i>Not available with (6) & (7) arm</i>	L5 10" Cylinder \$0
D2 Adjustable Lumbar Support \$100	B7 26" Black Aluminum \$100		L7 7" Cylinder \$0
E ESD* \$290			
J Upholstered Arm Pad \$65 <i>Only available on (2) arm</i>	Chair Cylinders	Connexion® Arm Attachments	Footrings for stool cylinders only
N N-dulgent® Memory Foam \$125	L1 3" Cylinder \$0	A1 Tablet Holder \$149 <i>Requires (Z1) Connexion Arm</i>	R1 18" Black Plastic \$60
N2 TheraGel™ Memory Foam \$150	L3 5" Cylinder \$0		R2 20" Chrome \$80
	L13 7" Dual Stage \$0	Guardian – Bullet Resistant Vest	NeXtep® for stool cylinders only
	L14 10" Dual Stage \$0	G Guardian \$1,960 <i>Center or Ballistic Only</i>	R8 8" w/Casters \$185
Casters/Glides	Headrest		R10 10" w/Casters \$185
C1 Hard Floor \$25	H6 Dual Pivot \$280 <i>Matching upholstery</i>		R18 8"/10" w/Casters \$295
C2 Glides \$25			RW8 Wide 8" w/Casters \$295
C3 Occupied Braking \$185			RW10 Wide 10" w/Casters \$295
C4 Unoccupied Braking \$60			

Also available w/glides.

For additional stool options see page 110.

Cozi® 24/7

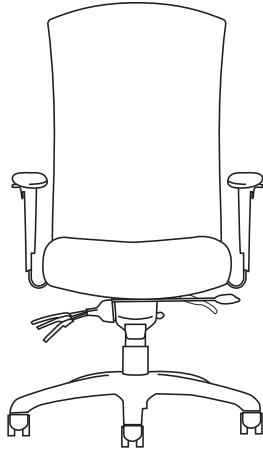

CZN6608

Task/Conference

Features

- Up to 11 active adjustments
- Standard with upholstered back outer
- 24/7 Continuous-shift 5-year warranty only available on upholstery with a double rub rating of over 1,000,000
- Passive weight dispersion design
- Generous foam for optimal comfort
- Optional headrest

Standard Features

- No Arms
- Carpet Casters
- 26" Black Base
- 5" Intensive Use Cylinder
- Seat Slider

Guardian®

The Guardian is an NIJ Level II compliant bullet resistant vest that will provide protection against regular powered 9mm handguns, up to .357 Magnums. The vest fits over the back of the chair and is easily removable.

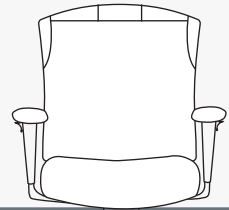

Step 1 — Model Number

Series Code	Select a Back	Select a Seat	Select an Arm	Mech
CZN Cozi	5 Mid Back 6 High Back	6 Medium Seat 7 Large Seat 8 Extra Large Seat <i>Supports up to 400 lbs</i>	0 4" Adjustable \$125 4 Swing \$295 5 No Arms \$0 6 360° w/Oversized Black Vinyl \$400 7 360° w/Oversized Fabric/Leather \$440 8 360° NP \$175	8 Multi-tilt 
CZN	5	6	0	8

Supports up to 350 lbs

Supports up to 400 lbs

Cozi® 24/7



CZN5658	CZN5758	CZN6658	CZN6758	CZN5858	CZN6858
\$1,076	\$1,112	\$1,163	\$1,188	\$1,341	\$1,418
\$1,136	\$1,172	\$1,223	\$1,248	\$1,401	\$1,478
\$1,196	\$1,232	\$1,283	\$1,308	\$1,461	\$1,538
\$1,266	\$1,302	\$1,353	\$1,378	\$1,531	\$1,608
\$1,336	\$1,372	\$1,423	\$1,448	\$1,601	\$1,678
\$1,416	\$1,452	\$1,503	\$1,528	\$1,681	\$1,758
\$1,496	\$1,532	\$1,583	\$1,608	\$1,761	\$1,838
\$1,586	\$1,622	\$1,673	\$1,698	\$1,851	\$1,928
\$1,676	\$1,712	\$1,763	\$1,788	\$1,941	\$2,018

Grade 1
Grade 2
Grade 3
Grade 4
Grade 5
Grade 6
Grade 7
Grade 8
Grade 9

39 x 26 x 26	39 x 26 x 26	43 x 26 x 26	43 x 26 x 26	39 x 26 x 26	41 x 26 x 26	Chair (H x W x D)
51.5 lbs	51.5 lbs	52 lbs	52 lbs	59 lbs	59 lbs	Chair Weight
19.5	22	19.5	22	23	23	Seat Width
16.5 – 21.5	16.5 – 21.5	16.5 – 21.5	16.5 – 21.5	19.25 – 23.75	19.25 – 23.75	Seat Height
16 – 18	16 – 18	16 – 18	16 – 18	19 – 21	19 – 21	Seat Depth
F5° – R10°	F8° – R18°	F5° – R10°	F8° – R18°	F5° – R10°	F5° – R10°	Seat Angle
19	19	19	19	19	19	Back Width
22 – 25	22 – 25	23 – 26	23 – 26	20 – 23	22 – 25	Back Height
105° – 120°	105° – 120°	105° – 120°	105° – 120°	105° – 120°	105° – 120°	Back Angle
3	3	3	3	3	3	Lumbar Range
26	26	26	26	26	26	Base Diameter
2 yd	2 yd	2 yd	2 yd	3 yd	3 yd	COM Yardage
36 x 26 x 19	36 x 26 x 19	36 x 26 x 19	36 x 26 x 19	28 x 26 x 24	28 x 26 x 24	Shipping Box (L x W x H)
61.5 lbs	61.5 lbs	62 lbs	62 lbs	69 lbs	69 lbs	Shipping Weight
KD	KD	KD	KD	KD	KD	Shipping Method

All measurements are nominal and shown in inches.
Specs may differ for stools.

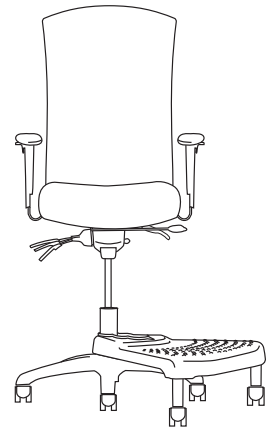

CZN6608-L5-R8

Step 2 — Add option codes after model number COZ5638 - __ - __

General	Casters/Glides	Chair Cylinders	Stool Cylinders
CR Cleanroom to Class 100 \$120	C1 Hard Floor \$25	L1 3" Cylinder \$0	L4 8" Cylinder \$55
D2 Adjustable Lumbar Support \$100		L13 7" Dual Stage \$55	L5 10" Cylinder \$55
E ESD* \$290	Bases	L14 10" Dual Stage \$55	L7 7" Cylinder \$55
N N-dulgent® Memory Foam \$125	B7 26" Black Aluminum \$100	Headrest	Footrings for stool cylinders only
N2 TheraGel™ Memory Foam \$150	B8 27" Brushed Aluminum \$140	H6 Dual Pivot \$280 <i>Matching upholstery</i>	R1 18" Black Plastic \$60
Finishes	B14 28" Intensive Use Black \$125	Guardian – Bullet Resistant Vest	R2 20" Chrome \$80
U1 Ballistic Upholstery \$0 <i>Back outer</i>		G Guardian \$1,960 <i>Center or Ballistic Only</i>	NeXtep® for stool cylinders only
			R8 8" w/Casters \$185
			R10 10" w/Casters \$185
			R18 8"/10" w/Casters \$295
			RW8 Wide 8" w/Casters \$295
			RW10 Wide 10" w/Casters \$295

Also available w/glides.

For additional stool options see page 110.

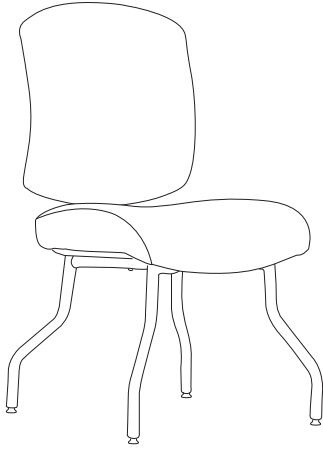

COG5654



Features

- Generous foam for optimal comfort
- Standard with upholstered back outer
- Passive weight dispersion design
- 2 base options

Standard Features

- No Arms
- Glides
- Black Frame

Step 1 — Model Number

Series Code	Back	Seat	Select an Arm	Select a Base
COG Cozi Guest	5 Mid Back	6 Medium Seat	3 3" Adjustable <i>Fixed Width</i> \$75 5 No Arms \$0 6 C Loop \$75 7 Chrome Loop \$75	4 4-leg  5 Sled 
COG	5	6	5	4

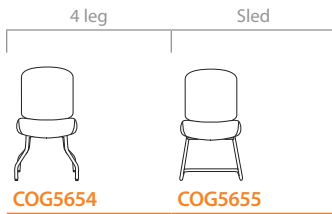

COG5654	COG5655
\$913	\$979
\$973	\$1,039
\$1,033	\$1,099
\$1,103	\$1,169
\$1,173	\$1,239
\$1,253	\$1,319
\$1,333	\$1,399
\$1,423	\$1,489
\$1,513	\$1,579

- Grade 1
- Grade 2
- Grade 3
- Grade 4
- Grade 5
- Grade 6
- Grade 7
- Grade 8
- Grade 9

37 x 20.5 x 24	36.5 x 20.5 x 24	Chair (H x W x D)
26.5 lbs	29.5 lbs	Chair Weight
19.5"	19.5"	Seat Width
18"	17.25"	Seat Height
18.5"	18.5"	Seat Depth
R3°	R4°	Seat Angle
19"	19"	Back Width
20"	20"	Back Height
109°	109°	Back Angle
20.5	20.5 x 23	Base Diameter
2 yd	2 yd	COM Yardage
30 x 27 x 39	30 x 27 x 39	Shipping Box (L x W x H)
36.5 lbs	39.5 lbs	Shipping Weight
FA	FA	Shipping Method

All measurements are nominal and shown in inches.

Step 2 — Add option code after model number COG5654 - __

General

CB Chrome Base	\$95
-----------------------	------

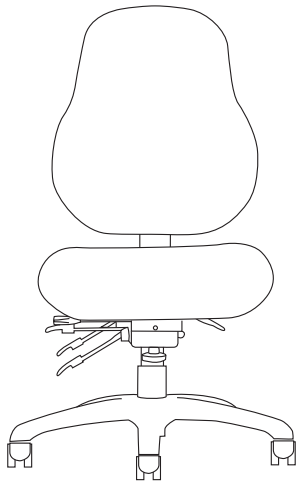

ES3256
High Back

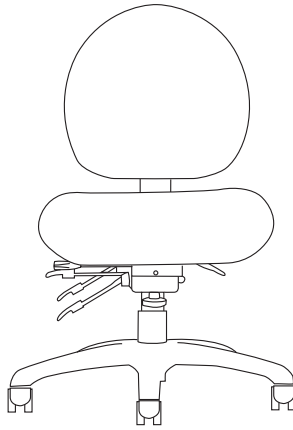

ES2256
Mid Back

Features

- Up to 13 active adjustments
- Contoured seat design
- Passive weight dispersion design
- Generous foam for optimal comfort
- Only available in Top Shelf, Cloud 9™ or Revive™

Standard Features

- No Arms
- Carpet Casters
- 26" Black Base
- 5" Cylinder
- Seat Slider

Need it Now? 5-day Quick Ship

Only standard features are available as Quick Ship unless otherwise noted.

QUICK SHIP ARMS

- 3 3" Adjustable Arms
- 5 No Arms
- 9 5-way Adjustable Arms

QUICK SHIP FABRICS

For available Quick Ship fabrics see page 8

Step 1 — Model Number

Series Code	Select a Back	Seat	Select an Arm		Mech
ES E-Series	<ul style="list-style-type: none"> 2 Mid Back 3 High Back 	<ul style="list-style-type: none"> 2 Medium Seat 	<ul style="list-style-type: none"> 0 4" Adjustable 2 Lateral Sliding 5 No Arms 9 5-way Adjustable 	<ul style="list-style-type: none"> \$125 \$140 \$0 \$150 	<ul style="list-style-type: none"> 6 Multi-tilt 
ES	3	2	0		6

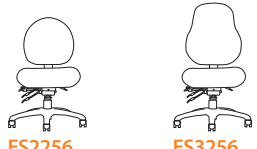

ES2256	ES3256
\$847	\$847
\$887	\$887
35.75 x 26 x 26	40 x 26 x 26
52.5 lbs	58 lbs
20.5	20.5
17.5 – 22.5	17.5 – 22.5
16 – 18	16 – 18
F1° – R16°	F1° – R16°
17.5	19.5
17 – 21	21 – 25
102° – 120°	97° – 112°
4	4
26	26
2 yd	2 yd
28 x 26 x 24	28 x 26 x 24
62.5 lbs	68 lbs
KD	KD

Top Shelf
Cloud 9 or Revive

Chair (H x W x D)
Chair Weight
Seat Width
Seat Height
Seat Depth
Seat Angle
Back Width
Back Height
Back Angle
Lumbar Range
Arm Width
COM Yardage
Shipping Box (L x W x H)
Shipping Weight
Shipping Method

All measurements are nominal and shown in inches.
Specs may differ for stools.

Step 2 — Add option codes after model number ES3206 - __ - __

General		
F	Fring® Footrest	\$50
	<i>Only available on (B0) base</i>	
Casters/Glides		
C1	Hard Floor	\$25

Chair Cylinders		
L1	3" Cylinder	\$0
L13	7" Dual Stage	\$55
L14	10" Dual Stage	\$55

Connexion® Arm		
Z1	Connexion Arm	\$350
Connexion® Arm Attachments		
A1	Tablet Holder	\$149
	<i>Requires (Z1) Connexion Arm</i>	

Stool Options

Stool Cylinders		
L4	8" Cylinder	\$55
L5	10" Cylinder	\$55
L7	7" Cylinder	\$55

Footrings for stool cylinders only		
R1	18" Black Plastic	\$60
R2	20" Chrome	\$80

NeXtep® for stool cylinders only		
R8	8" w/Casters	\$185
R10	10" w/Casters	\$185
R18	8"/10" w/Casters	\$295
RW8	Wide 8" w/Casters	\$295
RW10	Wide 10" w/Casters	\$295

Also available w/glides.

For additional stool options see page 110.



EMB2124
Pulled Fabric

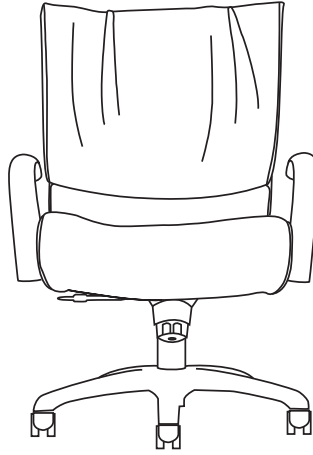

EMB2124-PT
Pillow Top

Features

- Up to 4 active adjustments
- Pillow top or pulled fabric upholstery
- Passive weight dispersion design
- Generous foam for optimal comfort
- Built-in lumbar

Standard Features

- C Loop Arms
- Carpet Casters
- 26" Black Base



TILT-SWIVEL







- 5" Cylinder

KNEE-TILT

- 3" Cylinder

Step 1 — Model Number

Series Code	Select a Back	Seat	Arm		Select a Base
EMB Embrace	1 Mid Back 2 High Back	1 Medium Seat	2 C Loop	\$0	4 Tilt-swivel  0 Knee-tilt 
EMB	2	1	2		4

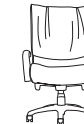
Tilt-swivel (Pulled)		Tilt-swivel (Pillow Top)		Knee-tilt (Pulled)		Knee-tilt (Pillow Top)		
								
EMB1124	EMB2124	EMB1124-PT	EMB2124-PT	EMB1120	EMB2120	EMB1120-PT	EMB2120-PT	
\$734	\$796	\$934	\$996	\$796	\$857	\$996	\$1,057	Grade 1
\$794	\$856	\$1,024	\$1,086	\$856	\$917	\$1,086	\$1,147	Grade 2
\$854	\$916	\$1,114	\$1,176	\$916	\$977	\$1,176	\$1,237	Grade 3
\$924	\$986	\$1,204	\$1,266	\$986	\$1,047	\$1,266	\$1,327	Grade 4
\$994	\$1,056	\$1,314	\$1,376	\$1,056	\$1,117	\$1,376	\$1,437	Grade 5
\$1,074	\$1,136	\$1,464	\$1,526	\$1,136	\$1,197	\$1,526	\$1,587	Grade 6
\$1,154	\$1,216	\$1,634	\$1,696	\$1,216	\$1,277	\$1,696	\$1,757	Grade 7
\$1,244	\$1,306	\$1,824	\$1,886	\$1,306	\$1,367	\$1,886	\$1,947	Grade 8
\$1,334	\$1,396	\$2,014	\$2,076	\$1,396	\$1,457	\$2,076	\$2,137	Grade 9
36 x 26 x 26	40 x 26 x 26	36 x 26 x 26	40 x 26 x 26	38.5 x 26 x 28	42.5 x 26 x 28	38.5 x 26 x 28	42.5 x 26 x 28	Chair (H x W x D)
57 lbs	57 lbs	57 lbs	57 lbs	57 lbs	57 lbs	57 lbs	57 lbs	Chair Weight
21	21	21	21	21	21	21	21	Seat Width
15.5 – 20.5	15.5 – 20.5	15.5 – 20.5	15.5 – 20.5	18 – 21	18 – 21	18 – 21	18 – 21	Seat Height
19.5	19.5	19.5	19.5	19.5	19.5	19.5	19.5	Seat Depth
R6° – F23°	R6° – F23°	R6° – F23°	R6° – F23°	R7° – F24°	R7° – F24°	R7° – F24°	R7° – F24°	Seat Angle
22	22	22	22	22	22	22	22	Back Width
22	25	22	25	22	25	22	25	Back Height
N/A	N/A	N/A	N/A	N/A	N/A	N/A	N/A	Back Angle
8	8	8	8	8	8	8	8	Arm Height
21.75	21.75	21.75	21.75	21.75	21.75	21.75	21.75	Arm Width
26	26	26	26	26	26	26	26	Base Diameter
2 yd	2 yd	2 yd	2 yd	2 yd	2 yd	2 yd	2 yd	COM Yardage – <i>Pulled</i>
4.5 yd	4.5 yd	4.5 yd	4.5 yd	4.5 yd	4.5 yd	4.5 yd	4.5 yd	COM Yardage – <i>Pillow Top</i>
37 x 23 x 22	37 x 23 x 22	37 x 23 x 22	37 x 23 x 22	37 x 23 x 22	37 x 23 x 22	37 x 23 x 22	37 x 23 x 22	Shipping Box (L x W x H)
67 lbs	67 lbs	67 lbs	67 lbs	67 lbs	67 lbs	67 lbs	67 lbs	Shipping Weight
KD	KD	KD	KD	KD	KD	KD	KD	Shipping Method

All measurements are nominal and shown in inches.
 Not available in Cloud 9™, Revive™ or Top Shelf upholstery.

Step 2 — Add option code after model number EMB2124 - ___

Finishes	Cylinders	Casters/Glides
CP Chrome Package <i>Chrome loop arm & polished aluminum base. Ships fully assembled</i>	L13 7" Dual Stage L14 10" Dual Stage	C1 Hard Floor
\$295	\$55	\$25
	\$55	

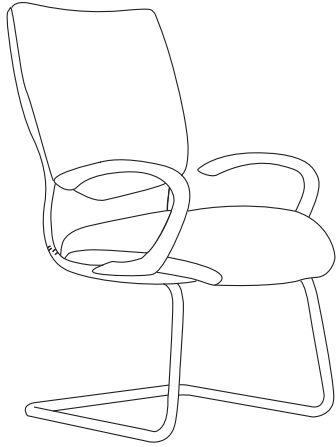

EMC022
Pulled Fabric

Task/Conference

Features





- Generous amount of foam in seat and back
- Fully upholstered back
- Sturdy, cantilever steel base

Standard Features

- No Arms
- Black Cantilever Base

Step 1 — Model Number

Series Code	Back	Seat	Select an Arm
EMC Embrace Guest	0 Mid Back	2 Medium Seat	0 No Arms 2 C Loop
EMC	0	2	2

w/o Arms (Pulled)	w/o Arms (Pillow Top)	w/Arms (Pulled)	w/Arms (Pillow Top)
			
EMC020	EMC020-PT	EMC022	EMC022-PT
\$617	\$817	\$719	\$919
\$677	\$907	\$779	\$1,009
\$737	\$997	\$839	\$1,099
\$807	\$1,087	\$909	\$1,189
\$877	\$1,197	\$979	\$1,299
\$957	\$1,347	\$1,059	\$1,449
\$1,037	\$1,517	\$1,139	\$1,619
\$1,127	\$1,707	\$1,229	\$1,809
\$1,217	\$1,897	\$1,319	\$1,999

- Grade 1**
- Grade 2**
- Grade 3**
- Grade 4**
- Grade 5**
- Grade 6**
- Grade 7**
- Grade 8**
- Grade 9**

38.5 x 25 x 28	38.5 x 25 x 28	38.5 x 25 x 28	38.5 x 25 x 28
49 lbs	49 lbs	49 lbs	49 lbs
21	21	21	21
20	20	20	20
20.5	20.5	20.5	20.5
21	21	21	21
22	22	22	22
2 yd	2 yd	2 yd	2 yd
4.5 yd	4.5 yd	4.5 yd	4.5 yd
29 x 26.5 x 38	29 x 26.5 x 38	29 x 26.5 x 38	29 x 26.5 x 38
59 lbs	59 lbs	59 lbs	59 lbs
FA	FA	FA	FA

- Chair (H x W x D)
- Chair Weight
- Seat Width
- Seat Height
- Seat Depth
- Back Width
- Back Height
- COM Yardage – *Pulled Fabric*
- COM Yardage – *Pillow Top*
- Shipping Box (L x W x H)
- Shipping Weight
- Shipping Method

All measurements are nominal and shown in inches.
Not available in Cloud 9™, Revive™ or Top Shelf upholstery.

Step 2 — Add option codes after model number EMC022 - __ - __

General

- CB Chrome Base \$95**
- CP Chrome Package \$295**
Chrome loop arm & polished aluminum base

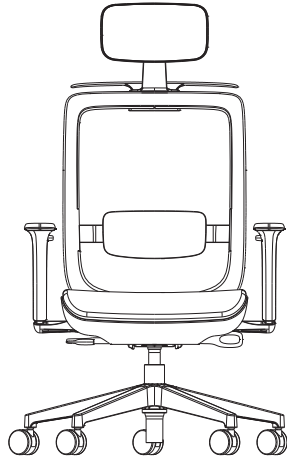

ICON4603-H2

Task/Conference

Features

- Medium gray mesh back
- Gray & black frame combination
- Replaceable/removable upholstered seat cushion – clips into place with no tools required
- Adjustable & removable lumbar support (easily slide up & down with no levers)
- Weight sensing mechanism without tension knob
- Finished seat bottom shell conceals mechanism
- 3 adjustment levers – height, synchro-tilt & seat slider

Standard Features

- No Arms
- Carpet Casters
- 26" Black Base
- 5" Cylinder
- Seat Slider
- N-dulgent® Memory Foam
- Adjustable Lumbar

Need it Now? 5-day Quick Ship

Only standard features are available as Quick Ship unless otherwise noted.

QUICK SHIP ARMS

0	1D
5	No Arms
3	3D

QUICK SHIP FABRICS

For available Quick Ship fabrics see page 8.

Step 1 — Model Number

Series Code	Select a Back	Seat	Select an Arm		Mech
ICON Icon	4 Mesh Back 5 Upholstered Back	6 Medium Seat	0 1D 3 3D 5 No Arms	\$40 \$70 \$0	3 Weight Sensitive 
ICON	4	6	0		3

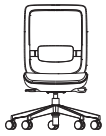

ICON4653



ICON5653

\$717	\$867	Grade 1
\$747	\$927	Grade 2
\$777	\$987	Grade 3
\$817	\$1,057	Grade 4
\$857	\$1,127	Grade 5
\$907	\$1,207	Grade 6
\$957	\$1,287	Grade 7
\$1,017	\$1,377	Grade 8
\$1,077	\$1,467	Grade 9

36.5 x 26 x 26	36.5 x 26 x 26	Chair (H x W x D)
36.5 lbs	36.5 lbs	Chair Weight
18.5	18.5	Seat Width
16 – 21	16 – 21	Seat Height
18 – 20	18 – 20	Seat Depth
R3° – R6°	R3° – R6°	Seat Angle
18	18	Back Width
20.5	20.5	Back Height
104° – 128°	104° – 128°	Back Angle
2.5	2.5	Lumbar Range
26	26	Base Diameter
1 yd	2 yd	COM Yardage
27 x 23 x 33	27 x 23 x 33	Shipping Box (L x W x H)
46.5 lbs	46.5 lbs	Shipping Weight
KD	KD	Shipping Method

All measurements are nominal and shown in inches. Specs may differ for stools.

ICONSC — Replacement Seat Cover	
Grade 1	\$100
Grade 2	\$130
Grade 3	\$160
Grade 4	\$200
Grade 5	\$240
Grade 6	\$290
Grade 7	\$340
Grade 8	\$400
Grade 9	\$460

Task/Conference

Step 2 — Add option codes after model number ICON4603 - __ - __

General		
N2	TheraGel™ Memory Foam	\$90

Bases		
B24	26" Polished Aluminum	\$90

Casters/Glides		
C1	Hard Floor	\$25
C2	Glides	\$25

Cylinders		
L13	7" Dual Stage	\$55
L14	10" Dual Stage	\$55

Headrests		
H1	Headrest	\$60
	<i>Matching upholstery</i>	
H2	Headrest w/Coat Hanger	\$90
	<i>Matching upholstery</i>	

Stool Options

Stool Cylinders		
L4	8" Cylinder	\$55
L5	10" Cylinder	\$55
L7	7" Cylinder	\$55

Footrings for stool cylinders only		
R1	18" Black Plastic	\$60
R2	20" Chrome	\$80

NeXtep® for stool cylinders only		
R9	10" w/Glides	\$135
R10	10" w/Casters	\$185
R21	10"/12" w/Glides	\$235
R22	10"/12" w/Casters	\$295
RW9	Wide 10" w/Glides	\$235
RW10	Wide 10" w/Casters	\$295

For additional stool options see page 110.

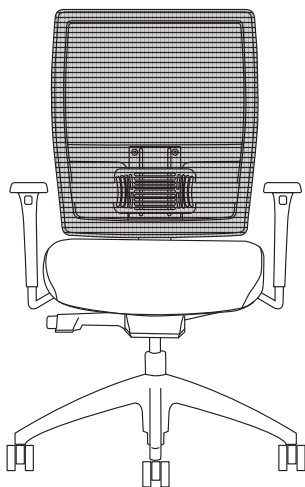

KNO4653

Features

- Mid and high mesh back options
- Adjustable lumbar support (easily slide up & down with no levers)
- Weight sensing mechanism without tension knob
- Height adjustable back
- Intuitive ergonomics

Standard Features

- No Arms
- Carpet Casters
- 26" High Crown Black Base
- 5" Cylinder
- Seat Slider
- Adjustable Lumbar
- Black Mesh

Need it Now? 5-day Quick Ship

QS Denotes Quick Ship models.

Only standard features are available as Quick Ship unless otherwise noted.



QUICK SHIP ARMS







- 3 3D
- 5 No Arms

QUICK SHIP FABRICS

For available Quick Ship fabrics see page 8.

Step 1 — Model Number

Series Code	Select a Back	Select a Seat	Select an Arm	Select a Mech
KNO Knomi	<ul style="list-style-type: none"> 4 Mesh Mid Back 6 Mesh High Back 	<ul style="list-style-type: none"> 6 Medium Seat 7 Large Seat 	<ul style="list-style-type: none"> 0 Fixed \$75 3 3D \$75 4 4D \$150 5 No Arms \$0 6 3D Chrome \$175 7 Chrome Loop \$295 8 4D Chrome \$250 	<ul style="list-style-type: none"> 2 Synchro  3 Weight Sensitive 
KNO	6	6	3	2

Synchro				Weight Sensitive				
								
KNO4652	KNO4752	KNO6652	KNO6752	KNO4653	KNO4753	KNO6653	KNO6753	
\$865	\$905	\$965	\$1,005	\$825	\$865	\$925	\$965	Grade 1
\$895	\$935	\$995	\$1,035	\$855	\$895	\$955	\$995	Grade 2
\$925	\$965	\$1,025	\$1,065	\$885	\$925	\$985	\$1,025	Grade 3
\$965	\$1,005	\$1,065	\$1,105	\$925	\$965	\$1,025	\$1,065	Grade 4
\$1,005	\$1,045	\$1,105	\$1,145	\$965	\$1,005	\$1,065	\$1,105	Grade 5
\$1,055	\$1,095	\$1,155	\$1,195	\$1,015	\$1,055	\$1,115	\$1,155	Grade 6
\$1,105	\$1,145	\$1,205	\$1,245	\$1,065	\$1,105	\$1,165	\$1,205	Grade 7
\$1,165	\$1,205	\$1,265	\$1,305	\$1,125	\$1,165	\$1,225	\$1,265	Grade 8
\$1,225	\$1,265	\$1,325	\$1,365	\$1,185	\$1,225	\$1,285	\$1,325	Grade 9
								Grade 1
								Grade 2
								Grade 3
								Grade 4
								Grade 5
								Grade 6
								Grade 7
								Grade 8
								Grade 9
35.5 x 26 x 26	35.5 x 26 x 26	40.5 x 26 x 26	40.5 x 26 x 26	35 x 26 x 26	35 x 26 x 26	40 x 26 x 26	40 x 26 x 26	Chair (H x W x D)
28 lbs	28 lbs	29 lbs	29 lbs	28 lbs	28 lbs	29 lbs	29 lbs	Chair Weight
19.5	21	19.5	21	19.5	21	19.5	21	Seat Width
17.25 – 22.25	17.25 – 22.25	17.25 – 22.25	17.25 – 22.25	17 – 22	17 – 22	17 – 22	17 – 22	Seat Height
17 – 19	17.5 – 19.5	17 – 19	17.5 – 19.5	17 – 19	17.5 – 19.5	17 – 19	17.5 – 19.5	Seat Depth
0° – R5.5°	0° – R5.5°	0° – R5.5°	0° – R5.5°	0° – R5.5°	0° – R5.5°	0° – R5.5°	0° – R5.5°	Seat Angle
20	20	19.5	19.5	20	20	19.5	19.5	Back Width
17 – 19	17 – 19	22 – 24	22 – 24	17 – 19	17 – 19	22 – 24	22 – 24	Back Height
102° – 123°	102° – 123°	102° – 123°	102° – 123°	102° – 123°	102° – 123°	102° – 123°	102° – 123°	Back Angle
3.5 – 8.5	3.5 – 8.5	3.5 – 8.5	3.5 – 8.5	3.5 – 8.5	3.5 – 8.5	3.5 – 8.5	3.5 – 8.5	Lumbar Range
26	26	26	26	26	26	26	26	Base Diameter
1	1	1	1	1	1	1	1	COM Yardage
36 x 26 x 19	36 x 26 x 19	36 x 26 x 19	36 x 26 x 19	36 x 26 x 19	36 x 26 x 19	36 x 26 x 19	36 x 26 x 19	Shipping Box (L x W x H)
38 lbs	38 lbs	39 lbs	39 lbs	38 lbs	38 lbs	39 lbs	39 lbs	Shipping Weight
KD	KD	KD	KD	KD	KD	KD	KD	Shipping Method

All measurements are nominal and shown in inches.

Task/Conference

Step 2 — Add option codes after model number KNO5636 - _ - _

General	Mesh Color	Casters/Glides	Cylinders
N N-dulgent® Memory Foam \$75	M1 Navy \$50	C1 Hard Floor \$25	L1 3" Cylinder \$0
N2 TheraGel™ Memory Foam \$90	M3 Beige \$50	C2 Glides \$25	
	M5 Silver \$50	C8 Chrome Carpet \$90	Headrest
		C9 Chrome Hard Floor \$100	H Headrest \$95
			<i>Black vinyl</i>
	Bases		
	B15 26" High Crown Polished Aluminum \$55		

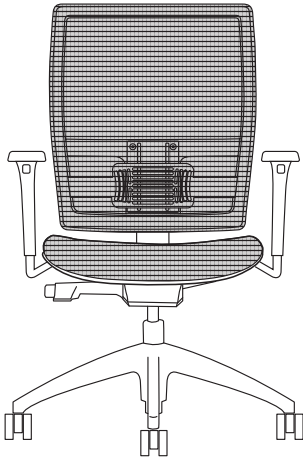

KNO6353

Task/Conference

Features

- Breathable mesh seat & back
- Adjustable lumbar
- Height adjustable back
- Intuitive ergonomics

Standard Features

- No Arms
- Carpet Casters
- 26" High Crown Black Base
- 5" Cylinder
- Seat Slider
- Adjustable Lumbar
- Black Mesh

Need it Now? 5-day Quick Ship

Only standard features are available as Quick Ship unless otherwise noted.



QUICK SHIP ARMS





- 3 3D
- 5 No Arms

QUICK SHIP FABRICS

For available Quick Ship fabrics see page 8.

Step 1 — Model Number

Series Code	Select a Back	Select a Seat	Select an Arm	Select a Mech
KNO Knomi	<ul style="list-style-type: none"> 4 Mesh Mid Back 6 Mesh High Back 	3 Mesh Seat	<ul style="list-style-type: none"> 0 Fixed \$75 3 3D \$75 4 4D \$150 5 No Arms \$0 6 3D Chrome \$175 7 Chrome Loop \$295 8 4D Chrome \$250 	<ul style="list-style-type: none"> 2 Synchro  3 Weight Sensitive 
KNO	6	3	3	2

Synchro		Weight Sensitive	
			
KNO4352	KNO6352	KNO4353	KNO6353
\$939	\$989	\$899	\$949

Mesh

35.5 x 26 x 26	40.5 x 26 x 26	35.5 x 26 x 26	40.5 x 26 x 26	Chair (H x W x D)
28 lbs	29 lbs	28 lbs	29 lbs	Chair Weight
20	20	20	20	Seat Width
16.5 – 21.5	16.5 – 21.5	16.25 – 21.25	16.25 – 21.25	Seat Height
17 – 19	17 – 19	17 – 19	17 – 19	Seat Depth
F1° – R4.5°	F1° – R4.5°	F1° – R4.5°	F1° – R4.5°	Seat Angle
20	19.5	20	19.5	Back Width
17 – 19	22 – 24	17 – 19	22 – 24	Back Height
102° – 123°	102° – 123°	102° – 123°	102° – 123°	Back Angle
3.5 – 8.5	3.5 – 8.5	3.5 – 8.5	3.5 – 8.5	Lumbar Range
26	26	26	26	Base Diameter
N/A	N/A	N/A	N/A	COM Yardage
36 x 26 x 19	36 x 26 x 19	36 x 26 x 19	36 x 26 x 19	Shipping Box (L x W x H)
38 lbs	39 lbs	38 lbs	39 lbs	Shipping Weight
KD	KD	KD	KD	Shipping Method

All measurements are nominal and shown in inches.

Task/Conference

Step 2 — Add option codes after model number KNO6332 - __ - __

Bases	Casters/Glides	Cylinders
B15 26" High Crown Polished Aluminum \$55	C0 Carpet \$0 C1 Hard Floor \$25 C2 Glides \$25 C8 Chrome Carpet \$90 C9 Chrome Hard Floor \$100	L1 3" Cylinder \$0 Headrest H Headrest \$95 <i>Black vinyl</i>



NV3402

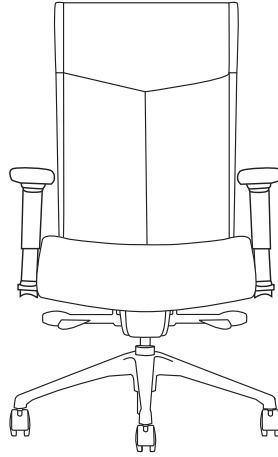

NV4122
Pillow Top

Features

- Up to 13 active adjustments
- High back with built-in lumbar
- Contoured seat with waterfall
- Passive weight dispersion design
- Removable inner pad in upper back
Only available on (4) back



Standard Features

- Lateral Sliding Arms
- 26" High Crown Black Base
- Carpet Casters
- 3" Cylinder
- Seat Slider

Step 1 — Model Number

Series Code	Select a Back	Select a Seat	Select an Arm	Mech
NV NV	<p>3 High Back</p> <p>4 High Back, Pillow Top</p>	<p>1 Medium Seat, Pillow Top</p> <p>2 Large Seat, Pillow Top</p> <p>4 Medium Seat</p>	<p>0 Polished Aluminum Loop \$0</p> <p>2 Lateral Sliding \$0</p> <p>5 No Arms (\$100)</p>	<p>2 Synchro</p> 
NV	4	1	2	2

Pillow Top Back

					
NV3422	NV3122	NV3222	NV4422	NV4122	NV4222
\$1,377	\$1,428	\$1,479	\$1,479	\$1,530	\$1,581
\$1,447	\$1,498	\$1,549	\$1,549	\$1,600	\$1,651
\$1,517	\$1,568	\$1,619	\$1,619	\$1,670	\$1,721
\$1,597	\$1,648	\$1,699	\$1,699	\$1,750	\$1,801
\$1,677	\$1,728	\$1,779	\$1,779	\$1,830	\$1,881
\$1,767	\$1,818	\$1,869	\$1,869	\$1,920	\$1,971
\$1,857	\$1,908	\$1,959	\$1,959	\$2,010	\$2,061
\$1,957	\$2,008	\$2,059	\$2,059	\$2,110	\$2,161
\$2,057	\$2,108	\$2,159	\$2,159	\$2,210	\$2,261

- Grade 1**
- Grade 2**
- Grade 3**
- Grade 4**
- Grade 5**
- Grade 6**
- Grade 7**
- Grade 8**
- Grade 9**

41.5 x 26 x 26	41.5 x 26 x 26	41.5 x 26 x 26	42 x 26 x 26	42 x 26 x 26	42 x 26 x 26	Chair (H x W x D)
45.5 lbs	45.5 lbs	45.5 lbs	46.5 lbs	46.5 lbs	46.5 lbs	Chair Weight
19.5	20.5	20.5	19.5	20.5	20.5	Seat Width
18 - 21	19.5 - 22.5	19.5 - 22.5	18 - 21	19.5 - 22.5	19.5 - 22.5	Seat Height
18.5 - 21.5	15.5 - 18.5	19 - 22	18.5 - 21	18 - 20.5	18 - 20.5	Seat Depth
F5° - R10°	F5° - R10°	F5° - R10°	F6° - 12°	F8° - R14°	F8° - R14°	Seat Angle
19	19	19	19	19	19	Back Width
23.5 - 27.5	23.5 - 27.5	23.5 - 27.5	24 - 28	23.5 - 27.5	23.5 - 27.5	Back Height
100° - 115°	100° - 115°	100° - 115°	98° - 114°	100° - 115°	100° - 115°	Back Angle
4	4	4	4	4	4	Lumbar Range
26	26	26	26	26	26	Base Diameter
2.25 yd	2.25 yd	2.25 yd	3 yd	3 yd	3 yd	COM Yardage
28 x 28 x 42	28 x 28 x 42	28 x 28 x 42	28 x 28 x 42	28 x 28 x 42	28 x 28 x 42	Shipping Box (L x W x H)
65.5 lbs	65.5 lbs	65.5 lbs	66.5 lbs	66.5 lbs	66.5 lbs	Shipping Weight
FA	FA	FA	FA	FA	FA	Shipping Method

All measurements are nominal and shown in inches.
 Not available in Cloud 9™, Revive™ or Top Shelf upholstery.

Task/Conference

Step 2 — Add option codes after model number NV4122 - _ - _

General	Casters/Glides	Bases	Cylinders
D2 Adjustable Lumbar Support \$100 <i>Not available on (3) back</i>	C0 Carpet \$0	B0 26" Black \$0	L3 5" Cylinder \$0
	C1 Hard Floor \$25	B6 26" Polished Aluminum \$140	L13 7" Dual Stage \$55
	C8 Chrome Carpet \$90	B15 26" High Crown Polished Aluminum \$55	L14 10" Dual Stage \$55
	C9 Chrome Hard Floor \$100	B16 26" High Crown Black \$0	
Finishes			
J Upholstered Arm Pad \$65 <i>Only available on (2) arm</i>			

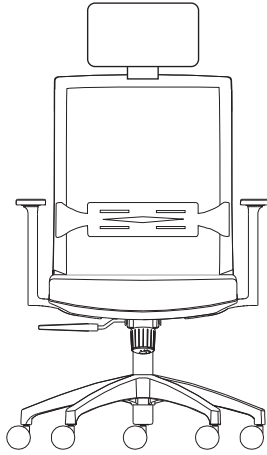

REN4604-D3-H

Features

- Black mesh back & frame
- Tilt-swivel mechanism
- Heavy-duty casters & base

Standard Features

- No Arms
- Carpet Casters
- 26" Black Base
- 5" Cylinder
- Adjustable Lumbar

Need it Now? 5-day Quick Ship

Only standard features are available as Quick Ship unless otherwise noted.

QUICK SHIP ARMS

- 0 Adjustable Arms
- 5 No Arms

QUICK SHIP FABRICS

For available Quick Ship fabrics see page 8.

Step 1 — Model Number

Series Code	Back	Seat	Select an Arm	Mech
REN Renati	4 Mesh Back	6 Medium Seat	0 Adjustable Arms \$40 5 No Arms \$0	4 Tilt-swivel 
REN	4	6	0	4



REN4654

\$507	Grade 1
\$537	Grade 2
\$567	Grade 3
\$607	Grade 4
\$647	Grade 5
\$697	Grade 6
\$747	Grade 7
\$807	Grade 8
\$867	Grade 9

37 x 26 x 26	Chair (H x W x D)
28.5 lbs	Chair Weight
19.5	Seat Width
16 – 21	Seat Height
18.5	Seat Depth
F1° – R16°	Seat Angle
17.5	Back Width
21	Back Height
100° – 125°	Back Angle
2.5	Lumbar Range
26	Base Diameter
1 yd	COM Yardage
27 x 23 x 33	Shipping Box (L x W x H)
38.5 lbs	Shipping Weight
KD	Shipping Method

All measurements are nominal and shown in inches. Specs may differ for stools.

Step 2 — Add option codes after model number REN4604 - __ - __ -

Stool Options

General		Casters/Glides		Headrest		Stool Cylinders	
N	N-dulgent® Memory Foam \$75	C0	Carpet \$0	H	Headrest \$60	L4	8" Cylinder \$55
N2	TheraGel™ Memory Foam \$90	C1	Hard Floor \$25		<i>Matching upholstery</i>	L5	10" Cylinder \$55
		C2	Glides \$25			L7	7" Cylinder \$55
Bases		Cylinders				Footrings for stool cylinders only	
B24	26" Polished Aluminum \$90	L13	7" Dual Stage \$55			R1	18" Black Plastic \$60
		L14	10" Dual Stage \$55			R2	20" Chrome \$80
						NeXtep® for stool cylinders only	
						R9	10" w/Glides \$135
						R10	10" w/Casters \$185
						R21	10"/12" w/Glides \$235
						R22	10"/12" w/Casters \$295
						RW9	Wide 10" w/Glides \$235
						RW10	Wide 10" w/Casters \$295

For additional stool options see page 110.

Right Chair®

Task/Conference

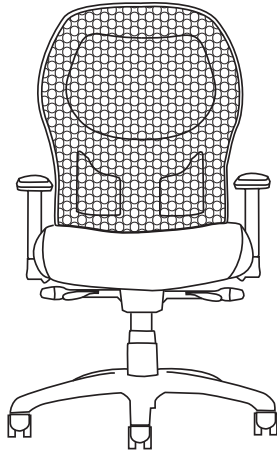

RCT4632

Features

- Up to 13 active adjustments
- High mesh back & contoured seat design
- Passive weight dispersion design
- Generous foam for optimal comfort
- Convert mesh back to upholstered w/optional sleeve
- Independent lumbar adjustment
- 2 headrest options

Standard Features

- No Arms
- 26" Black Base
- Carpet Casters
- 5" Cylinder
- Adjustable Lumbar

Need it Now? 5-day Quick Ship

Only standard features are available as Quick Ship unless otherwise noted.



QUICK SHIP ARMS

- 3 3" Adjustable
- 5 No Arms
- 9 5-way Adjustable

QUICK SHIP FABRICS

For available Quick Ship fabrics see page 8.

Step 1 — Model Number

Series Code	Back	Select a Seat	Select an Arm	Select a Mech
RCT Right Chair	4 Mesh Back	6 Medium Seat 7 Large Seat	0 4" Adjustable \$125 1 4" Adjustable w/Pivot \$150 2 Lateral Sliding \$140 3 3" Adjustable \$75 4 Swing \$295 5 No Arms \$0 6 C Loop \$75 7 Chrome Loop \$75 8 360° NP \$175 <i>Only available on (2) synchro mech</i> 9 5-way Adjustable \$150	2 Synchro  6 Multi-tilt 
RCT	4	6	3	2

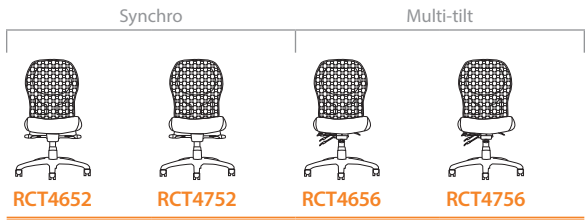

RCT4652	RCT4752	RCT4656	RCT4756
\$842	\$893	\$918	\$969
\$872	\$923	\$948	\$999
\$902	\$953	\$978	\$1,029
\$942	\$993	\$1,018	\$1,069
\$982	\$1,033	\$1,058	\$1,109
\$1,032	\$1,083	\$1,108	\$1,159
\$1,082	\$1,133	\$1,158	\$1,209
\$1,142	\$1,193	\$1,218	\$1,269
\$1,202	\$1,253	\$1,278	\$1,329

- Grade 1
- Grade 2
- Grade 3
- Grade 4
- Grade 5
- Grade 6
- Grade 7
- Grade 8
- Grade 9

40.5 x 26 x 26	40.5 x 26 x 26	39.5 x 26 x 26	39.5 x 26 x 26
37 lbs	37 lbs	48 lbs	48.5 lbs
19.5	22	19.5	22
16.5 - 21.5	16.5 - 21.5	15.25 - 20.25	15.25 - 20.25
16.5 - 19.5	16.5 - 19.5	16 - 18	19 - 21
F5° - R14°	F5° - R14°	F6° - R11°	F8° - R18°
19	19	19	19
23	23	23	23
102° - 120°	102° - 120°	100° - 115°	100° - 115°
4	4	4	4
26	26	26	26
1 yd	1 yd	1 yd	1 yd
28 x 26 x 24	28 x 26 x 24	28 x 26 x 24	28 x 26 x 24
47 lbs	47 lbs	58 lbs	58.5 lbs
KD	KD	KD	KD

- Chair (H x W x D)
- Chair Weight
- Seat Width
- Seat Height
- Seat Depth (OPTIONAL)
- Seat Angle
- Back Width
- Back Height
- Back Angle
- Lumbar Range
- Base Diameter
- COM Yardage
- Shipping Box (L x W x H)
- Shipping Weight
- Shipping Method

All measurements are nominal and shown in inches.

Step 2 — Add option codes after model number RCT4632 - __ - __

General	Back Sleeve – Back of sleeve made w/Spacer	Bases	Connexion® Arm
F Fring® Footrest \$50 <i>Only available on (B0) base</i>	S1 Grade 1 \$110	B6 26" Polished Aluminum \$140	Z1 Connexion Arm \$350 <i>Not available with (6) & (7) arm</i>
J Upholstered Arm Pad \$65 <i>Only available on (2) arm</i>	S2 Grade 2 \$160	B7 26" Black Aluminum \$100	
N N-dulgent® Memory Foam \$75	S3 Grade 3 \$200	B8 27" Brushed Aluminum \$140	
N2 TheraGel™ Memory Foam \$90	S4 Grade 4 \$240		Connexion® Arm Attachments
S Seat Slider \$75	S5 Grade 5 \$280	Cylinders	A1 Tablet Holder \$149 <i>Requires (Z1) Connexion Arm</i>
	S6 Grade 6 \$330	L1 3" Cylinder \$0	
	S7 Grade 7 \$380	L13 7" Dual Stage \$55	
	S8 Grade 8 \$430	L14 10" Dual Stage \$55	
	S9 Grade 9 \$480		
	Not available with a headrest	Headrests	
	Casters/Glides	HE Height Adjustable \$60 <i>Black vinyl</i>	
	C1 Hard Floor \$25	H5 Dual Pivot \$280 <i>Black faux leather</i>	
	C2 Glides \$25		

Right Chair®

Stool

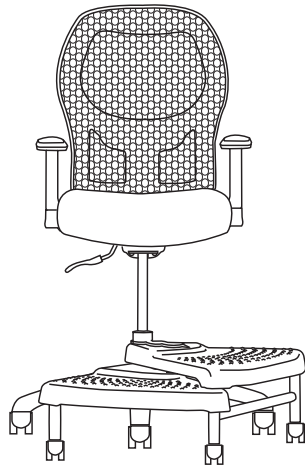

RCT4651

Task/Conference

Features

- High mesh back & contoured seat design
- Passive weight dispersion design
- Generous foam for optimal comfort
- Convert mesh back to upholstered with optional sleeve
- Independent lumbar adjustment
- 2 headrest options

Standard Features

- No Arms
- 26" Black Base
- Carpet Casters
- 8" Cylinder
- Adjustable Lumbar

Need it Now? 5-day Quick Ship

Only standard features are available as Quick Ship unless otherwise noted.

QUICK SHIP ARMS







- 3 3" Adjustable
- 5 No Arms
- 9 5-way Adjustable

QUICK SHIP FABRICS

For available Quick Ship fabrics see page 8.

Step 1 — Model Number

Series Code	Back	Select a Seat	Select an Arm	Select a Mech
RCT Right Chair	4 Mesh Back	6 Medium Seat 7 Large Seat	0 4" Adjustable \$125 1 4" Adjustable w/Pivot \$150 2 Lateral Sliding \$140 3 3" Adjustable \$75 4 Swing \$295 5 No Arms \$0 6 C Loop \$75 7 Chrome Loop \$75 8 360° NP \$175 9 5-way Adjustable \$150	1 Basic 8 Standard 9 Deluxe-tilt
RCT	4	6	3	8

Basic		Standard		Deluxe-tilt	
					
RCT4651	RCT4751	RCT4658	RCT4758	RCT4659	RCT4759
\$857	\$908	\$877	\$928	\$898	\$949
\$887	\$938	\$907	\$958	\$928	\$979
\$917	\$968	\$937	\$988	\$958	\$1,009
\$957	\$1,008	\$977	\$1,028	\$998	\$1,049
\$997	\$1,048	\$1,017	\$1,068	\$1,038	\$1,089
\$1,047	\$1,098	\$1,067	\$1,118	\$1,088	\$1,139
\$1,097	\$1,148	\$1,117	\$1,168	\$1,138	\$1,189
\$1,157	\$1,208	\$1,177	\$1,228	\$1,198	\$1,249
\$1,217	\$1,268	\$1,237	\$1,288	\$1,258	\$1,309
44.5 x 26 x 26	44.5 x 26 x 26	45 x 26 x 26	45 x 26 x 26	45 x 26 x 26	45 x 26 x 26
34.5 lbs	34.5 lbs	45.5 lbs	45.5 lbs	46 lbs	46 lbs
19.5	22	19.5	22	19.5	22
21 – 29	21.25 – 29.25	22.5 – 30.5	22.5 – 30.5	22.5 – 30.5	22.5 – 30.5
17 – 18	17 – 18	15.5 – 17.5	15.5 – 17.5	15.5 – 17.5	15.5 – 17.5
R4°	R4°	R3°	R3°	R4°	R4°
19	19	19	19	19	19
23	23	23	23	23	23
102°	102°	95° – 99°	95° – 99°	95° – 99°	95° – 99°
4	4	4	4	4	4
26	26	26	26	26	26
1 yd	1 yd	1 yd	1 yd	1 yd	1 yd
28 x 26 x 24	28 x 26 x 24	28 x 26 x 24	28 x 26 x 24	28 x 26 x 24	28 x 26 x 24
44.5 lbs	44.5 lbs	55.5 lbs	55.5 lbs	56 lbs	56 lbs
KD	KD	KD	KD	KD	KD

- Grade 1**
- Grade 2**
- Grade 3**
- Grade 4**
- Grade 5**
- Grade 6**
- Grade 7**
- Grade 8**
- Grade 9**

- Chair (H x W x D)
- Chair Weight
- Seat Width
- Seat Height
- Seat Depth (OPTIONAL)
- Seat Angle
- Back Width
- Back Height
- Back Angle
- Lumbar Range
- Base Diameter
- COM Yardage
- Shipping Box (L x W x H)
- Shipping Weight
- Shipping Method

All measurements are nominal and shown in inches.

Step 2 — Add option codes after model number RCT4638 - _ - _

General	Casters/Glides	Chair Cylinders	Footrings for stool cylinders only
J Upholstered Arm Pad \$65 <i>Only available on (2) arm</i>	C1 Hard Floor \$25	L1 3" Cylinder \$0	R1 18" Black Plastic \$60
N N-dulgent® Memory Foam \$75	C2 Glides \$25	L3 5" Cylinder \$0	R2 20" Chrome \$80
N2 TheraGel™ Memory Foam \$90	Bases	L13 7" Dual Stage \$0	NeXtep® for stool cylinders only
Back Sleeve – Back of sleeve made w/Spacer	B6 26" Polished Aluminum \$140	L14 10" Dual Stage \$0	R8 8" w/Casters \$185
S1 Grade 1 \$110	Headrests	Stool Cylinders	R10 10" w/Casters \$185
S2 Grade 2 \$160	HE Height Adjustable \$60 <i>Black vinyl</i>	L5 10" Cylinder \$0	R18 8"/10" w/Casters \$295
S3 Grade 3 \$200	H5 Dual Pivot \$280 <i>Black faux leather</i>	L7 7" Cylinder \$0	RW8 Wide 8" w/Casters \$295
S4 Grade 4 \$240		Connexion® Arm	RW10 Wide 10" w/Casters \$295
S5 Grade 5 \$280		Z1 Connexion Arm \$350 <i>Not available with (6) & (7) arm</i>	<i>Also available w/glides.</i>
S6 Grade 6 \$330		Connexion® Arm Attachments	
S7 Grade 7 \$380		A1 Tablet Holder \$149 <i>Requires (Z1) Connexion Arm</i>	
S8 Grade 8 \$430			
S9 Grade 9 \$480			
Not available with a headrest			

For additional stool options see page 110.

Right Chair® Mesh

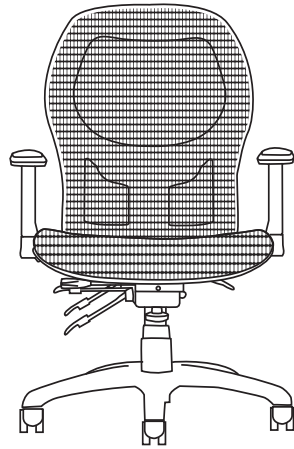

RCT5336

Task/Conference

Features

- Breathable mesh seat & back
- Adjustable lumbar
- 2 headrest options

Standard Features

- No Arms
- 26" Black Base
- Carpet Casters
- 5" Cylinder
- Adjustable Lumbar

Need it Now? 5-day Quick Ship

Only standard features are available as Quick Ship unless otherwise noted.



QUICK SHIP ARMS



- 3 3" Adjustable
- 5 No Arms
- 9 5-way Adjustable

QUICK SHIP FABRICS

For available Quick Ship fabrics see page 8.

Step 1 — Model Number

Series Code	Back	Seat	Select an Arm	Select a Mech
RCT Right Chair	5 Mesh Back	3 Mesh Seat	<ul style="list-style-type: none"> 2 Lateral Sliding \$140 3 3" Adjustable \$75 5 No Arms \$0 9 5-way Adjustable \$150 	<ul style="list-style-type: none"> 2 Synchro-tilt  6 Multi-tilt 
RCT	5	3	3	2

Synchro	Multi-tilt
	
RCT5352	RCT5356
\$918	\$995

Mesh

40.5 x 26 x 26	39.5 x 26 x 26	Chair (H x W x D)
41 lbs	41.5 lbs	Chair Weight
20	20	Seat Width
16.5 – 21.5	15.25 – 20.25	Seat Height
16.5 – 19.5	16.5 – 19	Seat Depth (OPTIONAL)
F1° – R5°	F6° – R11°	Seat Angle
19	19	Back Width
24	24	Back Height
100° – 120°	95° – 112°	Back Angle
4	4	Lumbar Range
26	26	Base Diameter
N/A	N/A	COM Yardage
28 x 26 x 24	28 x 26 x 24	Shipping Box (L x W x H)
51 lbs	51.5 lbs	Shipping Weight
KD	KD	Shipping Method

All measurements are nominal and shown in inches.

Step 2 — Add option codes after model number RCT5332 - __ - __

General		Casters/Glides		Bases		Headrests					
F	Fring® Footrest <i>Only available on (B0) base</i>	\$50	C1	Hard Floor	\$25	B6	26" Polished Aluminum	\$140	HE	Height Adjustable <i>Black vinyl</i>	\$60
J	Upholstered Arm Pad <i>Only available on (2) arm</i>	\$65	C2	Glides	\$25	Cylinders			H5	Dual Pivot <i>Black faux leather</i>	\$280
S	Seat Slider	\$75				L1	3" Cylinder	\$0			
						L13	7" Dual Stage	\$55			
						L14	10" Dual Stage	\$55			

Right Chair® Mesh Stool

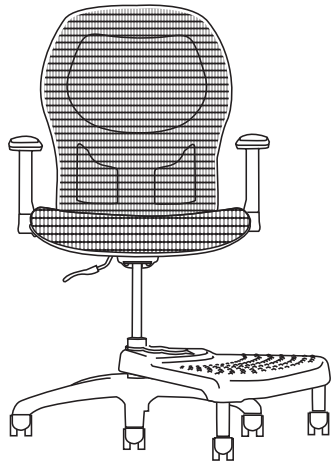

RCT5331-R10

Task/Conference

Features

- Breathable mesh seat & back
- Adjustable lumbar
- 2 headrest options

Standard Features

- No Arms
- 26" Black Base
- Carpet Casters
- 8" Cylinder
- Adjustable Lumbar

Need it Now? 5-day Quick Ship

Only standard features are available as Quick Ship unless otherwise noted.

QUICK SHIP ARMS



- 3 3" Adjustable
- 5 No Arms
- 9 5-way Adjustable

QUICK SHIP FABRICS

For available Quick Ship fabrics see page 8.

Step 1 — Model Number

Series Code	Back	Seat	Select an Arm		Select a Mech
RCT Right Chair	5 Mesh Back	3 Mesh Seat	2 Lateral Sliding	\$140	1 Basic
			3 3" Adjustable	\$75	
			5 No Arms	\$0	8 Standard
			9 5-way Adjustable	\$150	
					9 Deluxe-tilt
RCT	5	3	3		8

Basic	Standard	Deluxe-tilt
		
RCT5351	RCT5358	RCT5359
\$1,010	\$1,030	\$1,051
44.5 x 26 x 26	45 x 26 x 26	45 x 26 x 26
34.5 lbs	45.5 lbs	46 lbs
20	20	20
20.75 – 28.75	21.5 – 29.5	21.5 – 29.5
17.75 – 18.75	16 – 18	15.5 – 17.5
R4°	R3°	R4°
19	19	19
23	23	23
102°	95° – 99°	95° – 99°
4	4	4
26	26	26
N/A	N/A	N/A
28 x 26 x 24	28 x 26 x 24	28 x 26 x 24
44.5 lbs	55.5 lbs	56 lbs
KD	KD	KD

Mesh

- Chair (H x W x D)
- Chair Weight
- Seat Width
- Seat Height
- Seat Depth (OPTIONAL)
- Seat Angle
- Back Width
- Back Height
- Back Angle
- Lumbar Range
- Base Diameter
- COM Yardage
- Shipping Box (L x W x H)
- Shipping Weight
- Shipping Method

All measurements are nominal and shown in inches.

Step 2 — Add option codes after model number RCT5338 - __ - __

General	Chair Cylinders	Headrests	Footrings for stool cylinders only
J Upholstered Arm Pad \$65 <i>Only available on (2) arm</i>	L1 3" Cylinder \$0	HE Height Adjustable \$60 <i>Black vinyl</i>	R1 18" Black Plastic \$60
	L3 5" Cylinder \$0	H5 Dual Pivot \$280 <i>Black faux leather</i>	R2 20" Chrome \$80
	L13 7" Dual Stage \$0		NeXtep® for stool cylinders only
	L14 10" Dual Stage \$0		R8 8" w/Casters \$185
Casters/Glides	Stool Cylinders		R10 10" w/Casters \$185
C1 Hard Floor \$25	L5 10" Cylinder \$0		R18 8"/10" w/Casters \$295
C2 Glides \$25	L7 7" Cylinder \$0		RW8 Wide 8" w/Casters \$295
Bases			RW10 Wide 10" w/Casters \$295
B6 26" Polished Aluminum \$140			Also available w/glides.

For additional stool options see page 110.

Right Chair®

Guest

Task/Conference

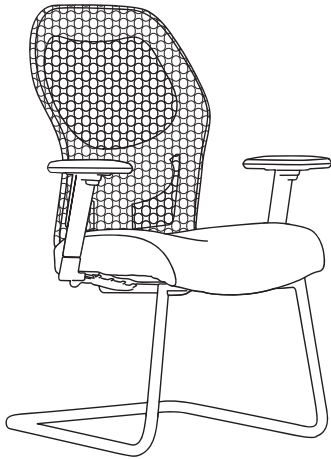

RCG4635



Features

- High back & contoured seat design
- Passive weight dispersion design
- Generous foam for optimal comfort

Standard Features

- No Arms
- Black Base

Step 1 — Model Number

Series Code	Back	Seat	Select an Arm	Select a Base
RCG Right Chair Guest	4 Mesh Back	6 Medium Seat	3 3" Adjustable <i>Fixed Width</i> \$75 5 No Arms \$0 6 C Loop \$75 7 Chrome Loop \$75	4 4-leg  5 Sled 
RCG	4	6	3	5

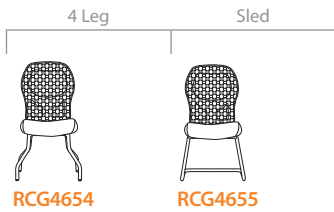

RCG4654	RCG4655
\$719	\$785
\$749	\$815
\$779	\$845
\$819	\$885
\$859	\$925
\$909	\$975
\$959	\$1,025
\$1,019	\$1,085
\$1,079	\$1,145

- Grade 1
- Grade 2
- Grade 3
- Grade 4
- Grade 5
- Grade 6
- Grade 7
- Grade 8
- Grade 9

40 x 20.5 x 24	39.5 x 20.5 x 24	Chair (H x W x D)
28 lbs	31 lbs	Chair Weight
19.5	19.5	Seat Width
18	17.25	Seat Height
17.5	17.5	Seat Depth
R3°	R4°	Seat Angle
19	19	Back Width
23	23	Back Height
100°	102°	Back Angle
4	4	Lumbar Range
20.5	20.5 x 23	Base Diameter
1 yd	1 yd	COM Yardage
30 x 27 x 39	30 x 27 x 39	Shipping Box (L x W x H)
38 lbs	41 lbs	Shipping Weight
FA	FA	Shipping Method

All measurements are nominal and shown in inches.

Step 2 — Add option codes after model number RCG4635 - ___

General

CB	Chrome Base	\$95
-----------	--------------------	-------------

Back Sleeve – Back of sleeve made w/Spacer

S1	Grade 1	\$110
S2	Grade 2	\$160
S3	Grade 3	\$200
S4	Grade 4	\$240
S5	Grade 5	\$280
S6	Grade 6	\$330
S7	Grade 7	\$380
S8	Grade 8	\$430
S9	Grade 9	\$480



U4ia4600

Features

- Up to 13 active adjustments
- Height adjustable mesh back
- Passive weight dispersion design
- Generous foam for optimal comfort
- Optional removable back sleeve for an upholstered look & feel

Standard Features

- No Arms
- Carpet Casters
- 26" Black Base
- 5" Cylinder
- Black Mesh Back

Need it Now? 5-day Quick Ship

Only standard features are available as Quick Ship unless otherwise noted.

QUICK SHIP ARMS

- 3 3" Adjustable Arms
- 5 No Arms
- 9 5-way Adjustable Arms

QUICK SHIP FABRICS

For available Quick Ship fabrics see page 8.

Step 1 — Model Number

Series Code	Back	Select a Seat	Select an Arm	Mech																											
U4ia U4ia	4 Mid Back	6 Medium Seat 7 Large Seat	<table border="0"> <tr><td>0</td><td>4" Adjustable</td><td>\$125</td></tr> <tr><td>1</td><td>4" Adjustable w/Pivot</td><td>\$150</td></tr> <tr><td>2</td><td>Lateral Sliding</td><td>\$140</td></tr> <tr><td>3</td><td>3" Adjustable</td><td>\$75</td></tr> <tr><td>4</td><td>Swing</td><td>\$295</td></tr> <tr><td>5</td><td>No Arms</td><td>\$0</td></tr> <tr><td>6</td><td>C Loop</td><td>\$75</td></tr> <tr><td>7</td><td>Chrome Loop</td><td>\$75</td></tr> <tr><td>9</td><td>5-way Adjustable</td><td>\$150</td></tr> </table>	0	4" Adjustable	\$125	1	4" Adjustable w/Pivot	\$150	2	Lateral Sliding	\$140	3	3" Adjustable	\$75	4	Swing	\$295	5	No Arms	\$0	6	C Loop	\$75	7	Chrome Loop	\$75	9	5-way Adjustable	\$150	2 Synchro 
0	4" Adjustable	\$125																													
1	4" Adjustable w/Pivot	\$150																													
2	Lateral Sliding	\$140																													
3	3" Adjustable	\$75																													
4	Swing	\$295																													
5	No Arms	\$0																													
6	C Loop	\$75																													
7	Chrome Loop	\$75																													
9	5-way Adjustable	\$150																													
U4ia	4	6	3	2																											

Synchro



U4ia4652	U4ia4752
\$791	\$842
\$821	\$872
\$851	\$902
\$891	\$942
\$931	\$982
\$981	\$1,032
\$1,031	\$1,082
\$1,091	\$1,142
\$1,151	\$1,202

- Grade 1**
- Grade 2**
- Grade 3**
- Grade 4**
- Grade 5**
- Grade 6**
- Grade 7**
- Grade 8**
- Grade 9**

38 x 26 x 26	38 x 26 x 26	Chair (H x W x D)
36 lbs	36 lbs	Chair Weight
19.5	22	Seat Width
16.5 – 21.5	16.5 – 21.5	Seat Height
16.5 – 19	16.5 – 19	Seat Depth (OPTIONAL)
F5° – R15°	F5° – R15°	Seat Angle
19	19	Back Width
20.5 – 23.5	20.5 – 23.5	Back Height
100° – 128°	100° – 128°	Back Angle
3	3	Lumbar Range
26	26	Base Diameter
1 yd	1 yd	COM Yardage
36 x 26 x 19	36 x 26 x 19	Shipping Box (L x W x H)
46 lbs	46 lbs	Shipping Weight
KD	KD	Shipping Method

All measurements are nominal and shown in inches.

Step 2 — Add option codes after model number U4ia4632 - _ - _

General		Back Sleeve (back of sleeve made w/Spacer)		Casters/Glides		Cylinders		
F	Fring® Footrest <i>Only available on (B0) base</i>	\$50	S1 Grade 1	\$110	C1 Hard Floor	\$25	L1 3" Cylinder	\$0
J	Upholstered Arm Pad <i>Only available on (2) arm</i>	\$65	S2 Grade 2	\$160	C2 Glides	\$25	L13 7" Dual Stage	\$55
N	N-dulgent® Memory Foam	\$75	S3 Grade 3	\$200			L14 10" Dual Stage	\$55
N2	TheraGel™ Memory Foam	\$90	S4 Grade 4	\$240	Bases		Connexion® Arm	
S	Seat Slider	\$75	S5 Grade 5	\$280	B6 26" Polished Aluminum	\$140	Z1 Connexion Arm	\$350
Mesh Color			SU Stitched Ultraleather™	\$295			<i>Not available with (6) & (7) arm</i>	
M1	London (Navy)	\$25	S6 Grade 6	\$330			Connexion® Arm Attachments	
M2	Cognac (Red)	\$25	S7 Grade 7	\$380			A1 Tablet Holder	\$149
M3	Mocha (Brown)	\$25	S8 Grade 8	\$430			<i>Requires (Z1) Connexion Arm</i>	
M4	Ivory	\$25	S9 Grade 9	\$480				
M5	Silver	\$25	NR Non-removable	\$0				

U4ia® Stool

Task/Conference

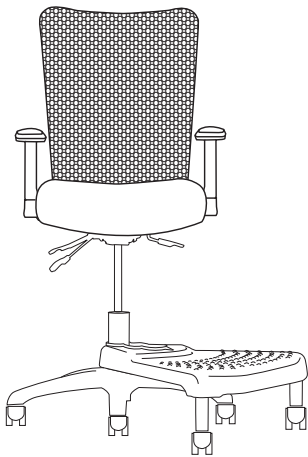

U4ia4608-R8

Features

- Passive weight dispersion design
- Generous foam for optimal comfort
- Optional removable back sleeve for an upholstered look & feel

Standard Features

- No Arms
- Carpet Casters
- 26" Black Base
- 8" Cylinder
- Black Mesh Back

Need it Now? 5-day Quick Ship

Only standard features are available as Quick Ship unless otherwise noted.

QUICK SHIP ARMS

3 3" Adjustable Arms

5 No Arms







9 5-way Adjustable Arms

QUICK SHIP FABRICS

For available Quick Ship fabrics see page 8.

Step 1 — Model Number

Series Code	Back	Select a Seat	Select an Arm	Select a Mech
U4ia U4ia	4 Mid Back	6 Medium Seat 7 Large Seat	0 4" Adjustable \$125 1 4" Adjustable w/Pivot \$150 2 Lateral Sliding \$140 3 3" Adjustable \$75 4 Swing \$295 5 No Arms \$0 6 C Loop \$75 7 Chrome Loop \$75 9 5-way Adjustable \$150	1 Basic 8 Standard 9 Deluxe-tilt
U4ia	4	6	3	8

Basic		Standard		Deluxe-tilt	
					
U4ia4651	U4ia4751	U4ia4658	U4ia4758	U4ia4659	U4ia4759
\$806	\$857	\$826	\$877	\$847	\$898
\$836	\$887	\$856	\$907	\$877	\$928
\$866	\$917	\$886	\$937	\$907	\$958
\$906	\$957	\$926	\$977	\$947	\$998
\$946	\$997	\$966	\$1,017	\$987	\$1,038
\$996	\$1,047	\$1,016	\$1,067	\$1,037	\$1,088
\$1,046	\$1,097	\$1,066	\$1,117	\$1,087	\$1,138
\$1,106	\$1,157	\$1,126	\$1,177	\$1,147	\$1,198
\$1,166	\$1,217	\$1,186	\$1,237	\$1,207	\$1,258

- Grade 1**
- Grade 2**
- Grade 3**
- Grade 4**
- Grade 5**
- Grade 6**
- Grade 7**
- Grade 8**
- Grade 9**

42.5 x 26 x 26	42.5 x 26 x 26	44.5 x 26 x 26	44.5 x 26 x 26	44.5 x 26 x 26	44.5 x 26 x 26	Chair (H x W x D)
32 lbs	32 lbs	40 lbs	40 lbs	40 lbs	40 lbs	Chair Weight
19.5	22	19.5	22	19.5	22	Seat Width
21.5 – 29.5	21.5 – 29.5	22.5 – 30.5	22.5 – 30.5	22.5 – 30.5	22.5 – 30.5	Seat Height
17 – 18	17 – 18	16.5 – 19	16.5 – 19	16.5 – 19	16.5 – 19	Seat Depth (OPTIONAL)
R4°	R4°	R3°	R3°	R4°	R4°	Seat Angle
19	19	19	19	19	19	Back Width
22	22	22	22	22	22	Back Height
97°	97°	95° – 102°	95° – 102°	95° – 102°	95° – 102°	Back Angle
N/A	N/A	N/A	N/A	N/A	N/A	Lumbar Range
26	26	26	26	26	26	Base Diameter
1 yd	1 yd	1 yd	1 yd	1 yd	1 yd	COM Yardage
36 x 26 x 19	36 x 26 x 19	36 x 26 x 19	36 x 26 x 19	36 x 26 x 19	36 x 26 x 19	Shipping Box (L x W x H)
42 lbs	42 lbs	50 lbs	50 lbs	50 lbs	50 lbs	Shipping Weight
KD	KD	KD	KD	KD	KD	Shipping Method

All measurements are nominal and shown in inches.

Step 2 — Add option codes after model number U4ia4638 - _ - _

General		Back Sleeve (back of sleeve made w/Spacer)		Bases		Connexion® Arm		
J	Upholstered Arm Pad <i>Only available on (2) arm</i>	\$65	S1 Grade 1	\$110	B6 26" Polished Aluminum	\$140	Z1 Connexion Arm <i>Not available with (6) & (7) arm</i>	\$350
N	N-dulgent® Memory Foam	\$75	S2 Grade 2	\$160	Chair Cylinders		Connexion® Arm Attachments	
N2	TheraGel™ Memory Foam	\$90	S3 Grade 3	\$200	L1 3" Cylinder	\$0	A1 Tablet Holder <i>Requires (Z1) Connexion Arm</i>	\$149
Mesh Color			S4 Grade 4	\$240	L3 5" Cylinder	\$0	NeXtep® for stool cylinders only	
M1	London (Navy)	\$25	S5 Grade 5	\$280	L13 7" Dual Stage	\$0	R8 8" w/Casters	\$185
M2	Cognac (Red)	\$25	S6 Grade 6	\$330	L14 10" Dual Stage	\$0	R10 10" w/Casters	\$185
M3	Mocha (Brown)	\$25	S7 Grade 7	\$380	Stool Cylinders		R18 8"/10" w/Casters	\$295
M4	Ivory	\$25	S8 Grade 8	\$430	L5 10" Cylinder	\$0	RW8 Wide 8" w/Casters	\$295
M5	Silver	\$25	S9 Grade 9	\$480	L7 7" Cylinder	\$0	RW10 Wide 10" w/Casters	\$295
			NR Non-removable <i>Make a back sleeve non-removable</i>	\$0	Footrings for stool cylinders only		Also available w/glides.	
			Casters/Glides		R1 18" Black Plastic	\$60		
			C1 Hard Floor	\$25	R2 20" Chrome	\$80		
			C2 Glides	\$25				

For additional stool options see page 110.

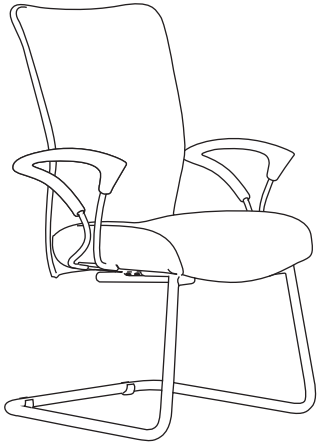

U4iaG4665



Features



- Mesh or upholstered back option
- Passive weight dispersion design
- Generous foam for optimal comfort
- Optional removable back sleeve for an upholstered look & feel

Standard Features

- No Arms
- Black Base

Step 1 — Model Number

Series Code	Back	Seat	Select an Arm	Select a Base
U4iaG U4ia Guest	4 Mid Back	6 Medium Seat	3 3" Adjustable <i>Fixe Width</i> \$75 5 No Arms \$0 6 C Loop \$75 7 Chrome Loop \$75	4 4-leg  5 Sled 
U4iaG	4	6	3	5

4-leg Base	Sled Base	
		
U4iaG4654	U4iaG4655	
\$729	\$796	Grade 1
\$759	\$826	Grade 2
\$789	\$856	Grade 3
\$829	\$896	Grade 4
\$869	\$936	Grade 5
\$919	\$986	Grade 6
\$969	\$1,036	Grade 7
\$1,029	\$1,096	Grade 8
\$1,089	\$1,156	Grade 9

38.75 x 20.5 x 24	38.25 x 20.5 x 24	Chair (H x W x D)
27.5 lbs	31 lbs	Chair Weight
19.5	19.5	Seat Width
18	17.25	Seat Height
18	18	Seat Depth
R3°	R4°	Seat Angle
19	19	Back Width
21	21	Back Height
104°	104°	Back Angle
N/A	N/A	Lumbar Range
20.5	20.5 x 23	Base Diameter
1 yd	1 yd	COM Yardage
30 x 27 x 39	30 x 27 x 39	Shipping Box (L x W x H)
37.5 lbs	40.5 lbs	Shipping Weight
FA	FA	Shipping Method

All measurements are nominal and shown in inches.

Step 2 — Add option codes after model number U4iaG4635 - __ - __

General	Mesh Color	Back Sleeve (back of sleeve made w/Spacer)
CB Chrome Base \$95	M0 Black Blurr \$0	S1 Grade 1 \$110
	M1 London (Navy) \$25	S2 Grade 2 \$160
	M2 Cognac (Red) \$25	S3 Grade 3 \$200
	M3 Mocha (Brown) \$25	S4 Grade 4 \$240
	M4 Ivory \$25	S5 Grade 5 \$280
	M5 Silver \$25	SU Stitched Ultraleather™ \$295
		S6 Grade 6 \$330
		S7 Grade 7 \$380
		S8 Grade 8 \$430
		S9 Grade 9 \$480
		NR Non-removable \$0



ULU4602

Task/Conference

Features

- Upholstered or mesh back
- Adjustable lumbar support (easily slide up & down with no levers)
- Weight sensing mechanism without tension knob
- Intuitive ergonomics

Standard Features

- No Arms
- Carpet Casters
- 25" Black Base
- 5" Cylinder
- Seat Slider
- Black Mesh
- Adjustable Lumbar

Need it Now? 5-day Quick Ship

QS Denotes Quick Ship models.

Only standard features are available as Quick Ship unless otherwise noted.



QUICK SHIP ARMS

- 3 3D
- 5 No Arms

QUICK SHIP FABRICS

For available Quick Ship fabrics see page 8.

Step 1 — Model Number

Series Code	Select a Back	Select a Seat	Select an Arm	Select a Mech
ULU Ulius	4 Mesh Back 5 Upholstered Back	6 Medium Seat 7 Large Seat	0 Fixed \$75 3 3D \$75 4 4D \$150 5 No Arms \$0 6 3D Chrome \$175 7 Chrome Loop \$295 8 4D Chrome \$250	2 Synchro  3 Weight Sensitive 
ULU	4	6	3	3

Synchro				Weight Sensitive				
ULU4652	ULU4752	ULU5652	ULU5752	ULU4653	ULU4753	ULU5653	ULU5753	
\$785	\$835	\$885	\$935	\$745	\$795	\$845	\$895	Grade 1
\$815	\$865	\$945	\$995	\$775	\$825	\$905	\$955	Grade 2
\$845	\$895	\$1,005	\$1,055	\$805	\$855	\$965	\$1,015	Grade 3
\$885	\$935	\$1,075	\$1,125	\$845	\$895	\$1,035	\$1,085	Grade 4
\$925	\$975	\$1,145	\$1,195	\$885	\$935	\$1,105	\$1,155	Grade 5
\$975	\$1,025	\$1,225	\$1,275	\$935	\$985	\$1,185	\$1,235	Grade 6
\$1,025	\$1,075	\$1,305	\$1,355	\$985	\$1,035	\$1,265	\$1,315	Grade 7
\$1,085	\$1,135	\$1,395	\$1,445	\$1,045	\$1,095	\$1,355	\$1,405	Grade 8
\$1,145	\$1,195	\$1,485	\$1,535	\$1,105	\$1,155	\$1,445	\$1,495	Grade 9
40 x 26 x 26	40 x 26 x 26	40 x 26 x 26	40 x 26 x 26	40 x 26 x 26	40 x 26 x 26	40 x 26 x 26	40 x 26 x 26	Chair (H x W x D)
30 lbs	30 lbs	30 lbs	30 lbs	28 lbs	28 lbs	28 lbs	28 lbs	Chair Weight
19.5	21	19.5	21	19.5	21	19.5	21	Seat Width
17.25 - 22.25	17.25 - 22.25	17.25 - 22.25	17.25 - 22.25	17 - 22	17 - 22	17 - 22	17 - 22	Seat Height
17.25 - 19.75	17.25 - 19.75	17 - 19.5	17 - 19.5	17.25 - 19.75	17.25 - 19.75	17 - 19.5	17 - 19.5	Seat Depth
R1.5° - R6°	R1.5° - R6°	R1.5° - R6°	R1.5° - R6°	R1° - R5.5°	R1° - R5.5°	R1° - R5.5°	R1° - R5.5°	Seat Angle
18.5	18.5	18.5	18.5	18.5	18.5	18.5	18.5	Back Width
22	22	22	22	22	22	22	22	Back Height
98° - 120°	98° - 120°	98° - 120°	98° - 120°	100° - 118°	100° - 118°	100° - 118°	100° - 118°	Back Angle
4.25 - 8.25	4.25 - 8.25	5 - 8	5 - 8	4.25 - 8.25	4.25 - 8.25	5 - 8	5 - 8	Lumbar Range
26	26	26	26	26	26	26	26	Base Diameter
1	1	3	3	1	1	3	3	COM Yardage
26 x 35.5 x 19	26 x 35.5 x 19	26 x 35.5 x 19	26 x 35.5 x 19	26 x 35.5 x 19	26 x 35.5 x 19	26 x 35.5 x 19	26 x 35.5 x 19	Shipping Box (L x W x H)
40 lbs	40 lbs	40 lbs	40 lbs	38 lbs	38 lbs	38 lbs	38 lbs	Shipping Weight
KD	KD	KD	KD	KD	KD	KD	KD	Shipping Method

All measurements are nominal and shown in inches.

Task/Conference

Step 2 — Add option codes after model number ULU4633 - _ - _

General		Mesh Color		Casters		Cylinders					
N	N-dulgent® Memory Foam	\$75	M1	Navy	\$50	C1	Hard Floor	\$25	L26	5" Chrome Cylinder	\$55
N2	TheraGel™ Memory Foam	\$90	M3	Beige	\$50						
			M5	Silver	\$50						
					Bases		Headrest				
					B36	25" Polished Aluminum	\$140	H	Headrest	\$95	

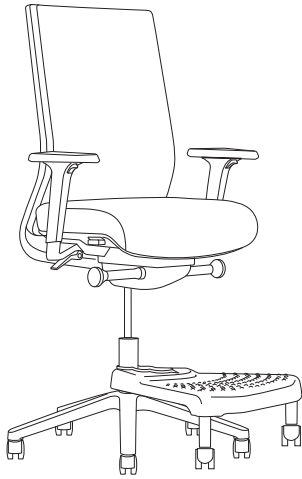

ULS5632

Task/Conference



Features

- Upholstered back
- Adjustable lumbar support (easily slide up & down with no levers)
- Weight sensing mechanism without tension knob
- Intuitive ergonomics

Standard Features

- No Arms
- Carpet Casters
- 26" Black Base
- 8" Cylinder
- Adjustable Lumbar

Step 1 — Model Number

Series Code	Select a Back	Select a Seat	Select an Arm	Select a Mech
ULS Ulius Stool	5 Upholstered Back	6 Medium Seat 7 Large Seat	0 Fixed \$75 3 3D \$75 4 4D \$150 5 No Arms \$0 6 3D Chrome \$175 7 Chrome Loop \$295 8 4D Chrome \$250	2 Synchro  3 Weight Sensitive 
ULS	5	6	3	3

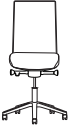
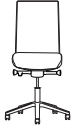
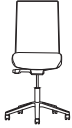
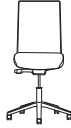
Synchro		Weight Sensitive	
			
ULS5652	ULS5752	ULS5653	ULS5753
\$885	\$935	\$845	\$895
\$945	\$995	\$905	\$955
\$1,005	\$1,055	\$965	\$1,015
\$1,075	\$1,125	\$1,035	\$1,085
\$1,145	\$1,195	\$1,105	\$1,155
\$1,225	\$1,275	\$1,185	\$1,235
\$1,305	\$1,355	\$1,265	\$1,315
\$1,395	\$1,445	\$1,355	\$1,405
\$1,485	\$1,535	\$1,445	\$1,495

- Grade 1**
- Grade 2**
- Grade 3**
- Grade 4**
- Grade 5**
- Grade 6**
- Grade 7**
- Grade 8**
- Grade 9**

46.25 x 26 x 26	46.25 x 26 x 26	46 x 26 x 26	46 x 26 x 26	Chair (H x W x D)
30 lbs	30 lbs	28 lbs	28 lbs	Chair Weight
19.5	21	19.5	21	Seat Width
23.25 - 31	23.25 - 31	23 - 30.75	23 - 30.75	Seat Height
17	17	17	17	Seat Depth
R1.5° - R6°	R1.5° - R6°	R1° - R5.5°	R1° - R5.5°	Seat Angle
18.5	18.5	18.5	18.5	Back Width
22	22	22	22	Back Height
98° - 120°	98° - 120°	100° - 118°	100° - 118°	Back Angle
5 - 8	5 - 8	5 - 8	5 - 8	Lumbar Range
26	26	26	26	Base Diameter
3	3	3	3	COM Yardage
26 x 35.5 x 19	26 x 35.5 x 19	26 x 35.5 x 19	26 x 35.5 x 19	Shipping Box (L x W x H)
41 lbs	41 lbs	39 lbs	39 lbs	Shipping Weight
KD	KD	KD	KD	Shipping Method

All measurements are nominal and shown in inches.

Step 2 — Add option codes after model number ULU5633 - _ - _

General		Bases		Headrest		NeXtep® for stool cylinders only					
N	N-dulgent® Memory Foam	\$75	B26	25" Black	\$0	H	Headrest	\$95	R8	8" w/Casters	\$185
N2	TheraGel™ Memory Foam	\$90	B36	25" Polished Aluminum	\$140				R10	10" w/Casters	\$185
Casters		Cylinders		Footrings					R18	8"/10" w/Casters	\$295
C1	Hard Floor	\$25	L5	10" Cylinder	\$0	R1	18" Black Plastic	\$60	RW8	Wide 8" w/Casters	\$295
		L7		7" Cylinder	\$0	R2	20" Chrome	\$80	RW10	Wide 10" w/Casters	\$295
		L13		7" Dual Stage	\$0				Also available w/glides.		
		L14		10" Dual Stage	\$0						

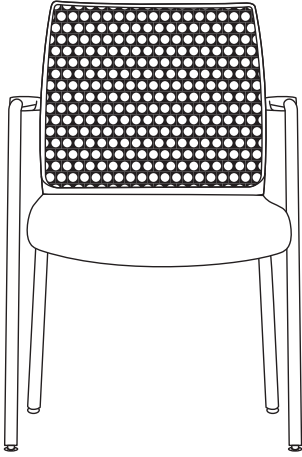

ULG264

Features

- Upholstered and mesh back options
- Wall saver legs

Standard Features

- Black Base

Step 1 — Model Number

Series Code	Select a Back	Select a Seat	Select a Base
<p>ULG Ulius Guest</p>	<p>2 Mesh Back</p> <p>3 Upholstered</p>	<p>6 Medium Seat</p>	<p>4 4-leg</p>
<p>ULG</p>	<p>2</p>	<p>6</p>	<p>4</p>



ULG264



ULG364

\$635	\$735	Grade 1
\$665	\$795	Grade 2
\$695	\$855	Grade 3
\$735	\$925	Grade 4
\$775	\$995	Grade 5
\$825	\$1,075	Grade 6
\$875	\$1,155	Grade 7
\$935	\$1,245	Grade 8
\$995	\$1,335	Grade 9

33.25 x 21.5 x 24.5	33.25 x 21.5 x 24.5	Chair (H x W x D)
22 lbs	22 lbs	Chair Weight
19	19	Seat Width
17.5	17.5	Seat Height
19	19	Seat Depth
18	18	Back Width
16	16	Back Height
8.5	8.5	Arm Height
21.5	21.5	Arm Width
1	2	COM Yardage
24 x 23 x 35	24 x 23 x 35	Shipping Box (L x W x H)
32 lbs	32 lbs	Shipping Weight
FA	FA	Shipping Method

All measurements are nominal and shown in inches.

Step 2 — Add option codes after model number ULG264 - __ - __

General

CB Chrome Base \$95

ACTIVE/GUEST SEATING

Neutral Posture's active/guest seating are ideal for high traffic areas like waiting rooms, cafes or multi-purpose spaces. Whether you're looking

for traditional guest chairs or seating for your collaborative areas, they provide support, comfort and style sure to bring sophistication to any area.

ACTIVE/GUEST SEATING

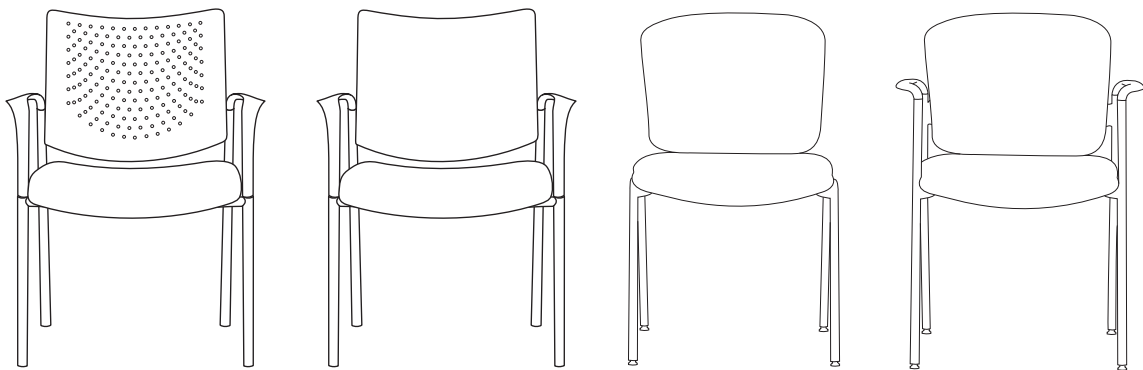

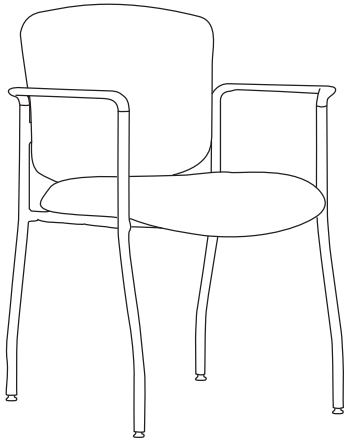

DCE211

Active/Guest

Features

- Stackable, up to 5 high
- Generous amount of foam in seat & back
- Fully upholstered back
- Self-leveling non-marking glides
- Optional arms
- Optional ganging device

Standard Features

- Black Base
- Glides

Step 1 — Model Number

Series Code	Back	Seat	Select an Arm
DCE Dice	2 Back	1 Seat	1 Arms 5 No Arms
DCE	2	1	1

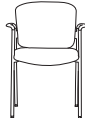
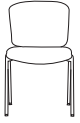

DCE215

DCE211

\$469	\$500	Grade 1
\$514	\$545	Grade 2
\$559	\$590	Grade 3
\$614	\$645	Grade 4
\$669	\$700	Grade 5
\$734	\$765	Grade 6
\$799	\$830	Grade 7
\$874	\$905	Grade 8
\$949	\$980	Grade 9

33 x 19 x 21.5	33 x 23.5 x 21.5	Chair (H x W x D)
19 lbs	20 lbs	Chair Weight
18	18	Seat Width
18.5	18.5	Seat Height
18	18	Seat Depth
19	19	Back Width
15.5	15.5	Back Height
N/A	21	Arm Width
2 yd	2 yd	COM Yardage
24 x 23 x 35	24 x 23 x 35	Shipping Box (L x W x H)
29 lbs	30 lbs	Shipping Weight
FA	FA	Shipping Method

All measurements are nominal and shown in inches.

Step 2 — Add option codes after model number DCE211 - __ - __

General

C6	Optional Casters <i>Set of 4</i>	\$30
CBL005	Ganging Device <i>2 per set</i>	\$30
CP	Chrome Package <i>Chrome frame</i>	\$40

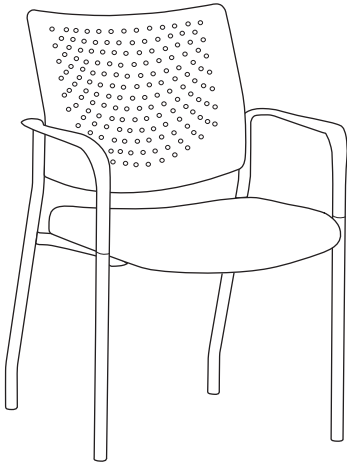

FAC160
Molded plastic back

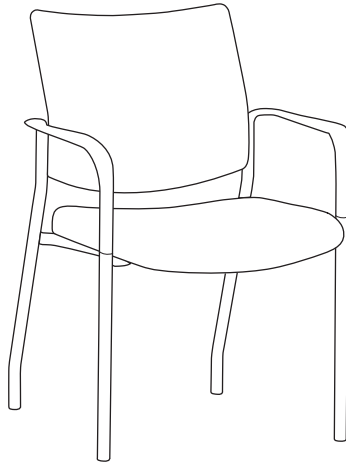

FAC260
Upholstered back

Features

- 9 frame colors available in addition to standard black
- Upholstered or molded plastic back
- Upholstered back style stacks 5-high
- Molded plastic back style stacks 6-high
- Integrated wall saver leg design
- Optional ganging device
- Optional arms

Standard Features

- Black Base
- Glides

Step 1 — Model Number

Series Code

FAC Facet

FAC

Select a Back

- 1** Molded Plastic Back
- 2** Upholstered Back

1

Seat

6 Medium Seat

6

Select an Arm

- 0** Arms
- 5** No Arms

0

Molded Plastic Back

Upholstered Back

FAC165	FAC160	FAC265	FAC260
\$392	\$414	\$434	\$457
\$437	\$459	\$479	\$502
\$482	\$504	\$524	\$547
\$537	\$559	\$579	\$602
\$592	\$614	\$634	\$657
\$657	\$679	\$699	\$722
\$722	\$744	\$764	\$787
\$797	\$819	\$839	\$862
\$872	\$894	\$914	\$937

- Grade 1
- Grade 2
- Grade 3
- Grade 4
- Grade 5
- Grade 6
- Grade 7
- Grade 8
- Grade 9

33 x 22.5 x 23	33 x 24.5 x 23	33 x 22.5 x 23	33 x 24.5 x 23	Chair (H x W x D)
16.5 lbs	18 lbs	18.5 lbs	20 lbs	Chair Weight
18.5	18.5	18.5	18.5	Seat Width
18.5	18.5	18.5	18.5	Seat Height
18.5	18.5	18.5	18.5	Seat Depth
18.5	18.5	18.5	18.5	Back Width
15	15	15	15	Back Height
N/A	24.5	N/A	24.5	Arm Width
0.75 yd	0.75 yd	1.25 yd	1.25 yd	COM Yardage
29 x 27 x 39	29 x 27 x 39	29 x 27 x 39	29 x 27 x 39	Shipping Box (L x W x H)
26.5 lbs	28 lbs	28.5 lbs	30 lbs	Shipping Weight
FA	FA	FA	FA	Shipping Method

All measurements are nominal and shown in inches.

Active/Guest

Step 2 — Add option codes after model number FAC160 - _ - _

General		Frame Color	
C6	Casters <i>Set of 4</i>	\$30	201T Cream \$120
CBL005	Ganging Device <i>2 per set</i>	\$30	202T Designer Beige \$120
			203T Grey \$120
			204T Jet Black \$120
			200T Sky White \$120
			303 Brass \$140
			301 Champagne \$140
			302 Platinum \$140

INDUSTRIAL/HEALTHCARE SEATING

Neutral Posture's industrial seating is designed for mobility and support during the busy workday. The industrial chairs were designed with a different mindset than most chairs because they serve such different and unique purposes. Industrial seating is designed to support some of the hardest workers out there. From the dental assistant on the Geo to the car mechanic on the Stratus Urethane, the Industrial seating plays an imperative role in the backbone of

almost every company. With an indefinite number of customization options in industrial seating, you can build and design the perfect industrial chair that will support you and work just as hard as you do. From the urethane seats that are stain resistant and can be used in the roughest environments to the upholstered Adapta Stool for more long term use, NP's industrial seating has everything you need to be supported and productive in your work.

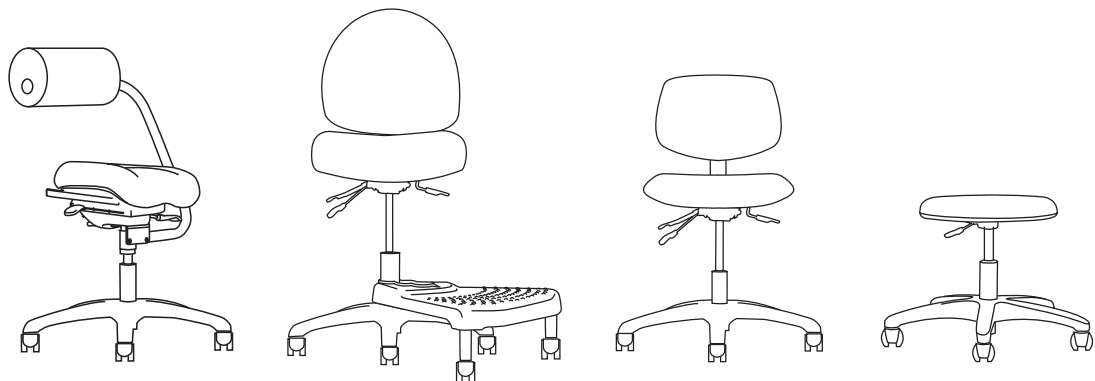

INDUSTRIAL/HEALTHCARE SEATING

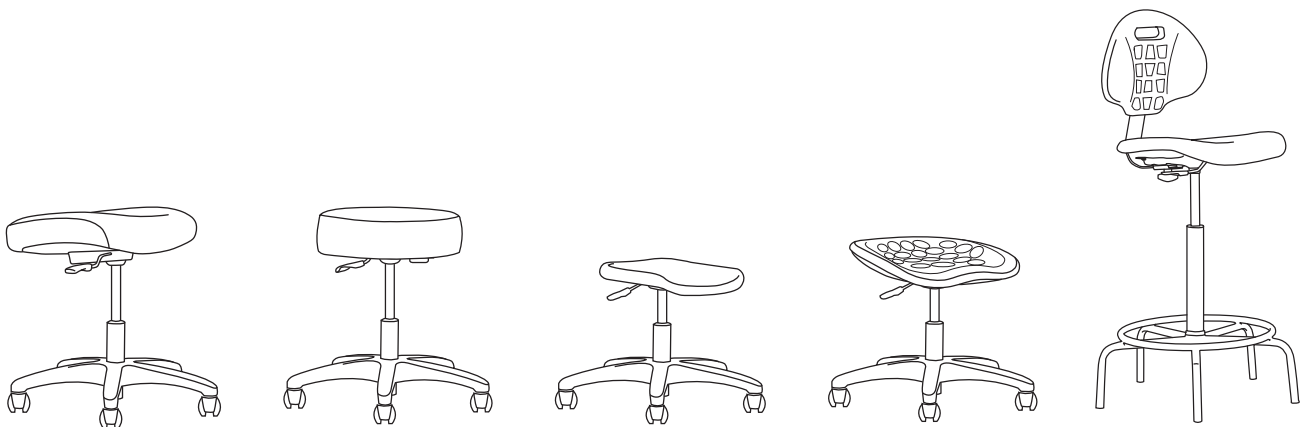

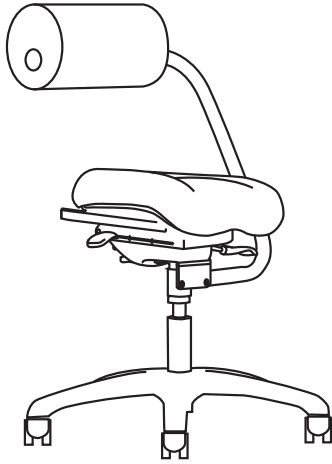

ABC1633

Features

- ESD & Cleanroom options available
- Adjustable seat height, depth, angle & tension
- Adjustable AbRest™ height
- 4-way AbRest™ rotation
- AbRest™ swivel/pivot

Standard Features

- Black Arm
- Hard Floor Casters
- 26" Black Base
- 5" Cylinder

Step 1 — Model Number

Series Code	Select a Back	Select a Seat	Arm	Mech
ABC AbChair	1 Urethane AbRest 2 Upholstered AbRest	3 Medium Seat 5 Urethane Seat 6 Medium Seat <i>Moderate Contour</i>	3 Black Arm	3 Tilt <i>w/Seat Slider</i>
ABC	2	3	3	3

ABC1333	ABC1533	ABC1633	ABC2333	ABC2533	ABC2633
\$1,112	\$1,142	\$1,224	\$1,112	\$1,142	\$1,224
\$1,142	N/A	\$1,254	\$1,172	\$1,202	\$1,284
\$1,172	N/A	\$1,284	\$1,232	\$1,262	\$1,344
\$1,212	N/A	\$1,324	\$1,302	\$1,332	\$1,414
\$1,252	N/A	\$1,364	\$1,372	\$1,402	\$1,484
\$1,302	N/A	\$1,414	\$1,452	\$1,482	\$1,564
\$1,352	N/A	\$1,464	\$1,532	\$1,562	\$1,644
\$1,412	N/A	\$1,524	\$1,622	\$1,652	\$1,734
\$1,472	N/A	\$1,584	\$1,712	\$1,742	\$1,824
37 x 28 x 28	37 x 28 x 28	37 x 28 x 28	37 x 28 x 28	37 x 28 x 28	37 x 28 x 28
45 lbs	49 lbs	47 lbs	45 lbs	49 lbs	47 lbs
22	19	23	22	19	23
21 – 26	20 – 25	22 – 27	21 – 26	20 – 25	22 – 27
17 – 19.75	16 – 18.75	18 – 20.75	17 – 19.75	16 – 18.75	18 – 20.75
R1° – F16°	R1° – F16°	R1° – F16°	R1° – F16°	R1° – F16°	R1° – F16°
26	26	26	26	26	26
1 yd	N/A	1 yd	2 yd	1 yd	2 yd
36 x 26 x 19	36 x 26 x 19	36 x 26 x 19	36 x 26 x 19	36 x 26 x 19	36 x 26 x 19
55 lbs	59 lbs	57 lbs	55 lbs	59 lbs	57 lbs
FA	FA	FA	FA	FA	FA

- Grade 1
- Grade 2
- Grade 3
- Grade 4
- Grade 5
- Grade 6
- Grade 7
- Grade 8
- Grade 9

- Chair (H x W x D)
- Chair Weight
- Seat Width
- Seat Height
- Seat Depth
- Seat Angle
- Base Diameter
- COM Yardage
- Shipping Box (L x W x H)
- Shipping Weight
- Shipping Method

All measurements are nominal and shown in inches. Specs may differ for stools.

Step 2 — Add option codes after model number ABC2333 - __ - __

General		Bases	
CR Cleanroom to Class 100	\$120	B0 26" Black	\$0
<i>Urethane AbRest only</i>		B9 28" Chrome	\$160
E ESD*	\$290	B22 22" Black	\$0
Casters/Glides		Chair Cylinder	
C1 Hard Floor	\$0	L3 5" Cylinder	\$0
C2 Glides	\$0	L14 10" Dual Stage	\$55
C3 Occupied Braking	\$185		
C4 Unoccupied Braking	\$60		

Stool Options

Stool Cylinder	
L4 8" Cylinder	\$55
Footrings for stool cylinders only	
R1 18" Black Plastic	\$60
R2 20" Chrome	\$80
NeXtep® for stool cylinders only	
R8 8" w/Casters	\$185
R10 10" w/Casters	\$185
R18 8"/10" w/Casters	\$295
RW8 Wide 8" w/Casters	\$295
RW10 Wide 10" w/Casters	\$295
Also available w/glides.	

For additional stool options see page 110.

Adapta™ Stool

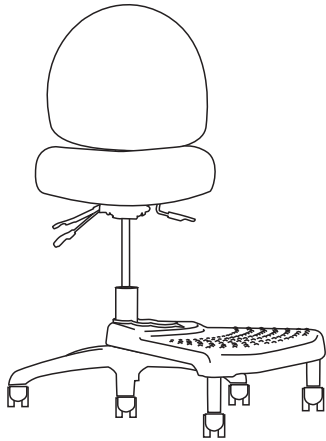

ADS5658-R8

Features



- Upholstered seat & back
- Generous foam for optimal comfort
- ESD & Cleanroom options available
- Optional NeXtep® platform with depth adjustments

Standard Features

- No Arms
- Hard Floor Casters
- 26" Black Base
- 8" Cylinder

Industrial/Healthcare

Step 1 — Model Number

Series Code	Back	Select a Seat	Select an Arm	Select a Mech
ADS Adapta	5 Mid Back	6 Medium Seat 7 Large Seat	0 4" Adjustable \$125 1 4" Adjustable w/Pivot \$150 2 Lateral Sliding \$140 3 3" Adjustable \$75 4 Swing \$295 5 No Arms \$0 6 C Loop \$75 7 Chrome Loop \$75 9 5-way Adjustable \$150	1 Basic  8 Standard  9 Deluxe-tilt 
ADS	5	6	3	8

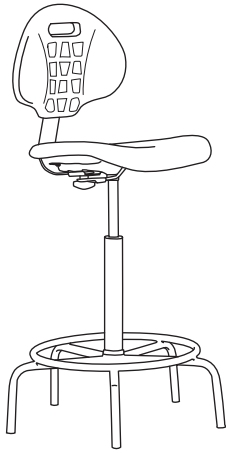

NCUGG1-L5-B20

Industrial/Healthcare

Features

- 3 active adjustments
- Concave low back
- Contoured, waterfall seat
- Textured urethane seat & back
- Wide variety of stool packages
- Urethane is resilient to harsh environments
- Cleanroom option available

Standard Features

- No Arms
- Hard Floor Casters
- 26" Black Base
- 5" Cylinder

Step 1 — Model Number

Series Code	Back	Seat	Mech
NCU Geo	G Geo Urethane Back	G Geo Urethane Seat	1 Basic 
NCU	G	G	1



NCUGG1

\$367

Urethane

38 x 26 x 26	Chair (H x W x D)
22 lbs	Chair Weight
18	Seat Width
15.5 – 20.5	Seat Height
16.5 – 19	Seat Depth
R 9°	Seat Angle
16.25	Back Width
14.5 – 18	Back Height
95° – 100°	Back Angle
N/A	Lumbar Range
26	Base Diameter
30.25 x 26 x 24	Shipping Box (L x W x H)
32 lbs	Shipping Weight
KD	Shipping Method

All measurements are nominal and shown in inches.
Specs may differ for stools.

Step 2 — Add option codes after model number NCUGG1 - __ - __

Stool Options

General		Bases		Chair Cylinders		Stool Cylinders		
CR	Cleanroom to Class 100	\$70	B0	26" Black	\$0	L1	3" Cylinder	\$0
F	Fring® Footrest	\$50	B3	26" Spider Ring w/Glides	\$140	L3	5" Cylinder	\$0
	<i>Only available on (B0) base</i>			<i>Special shipping required</i>		L13	7" Dual Stage	\$55
			B6	26" Polished Aluminum	\$140	L14	10" Dual Stage	\$55
Casters/Glides			B9	28" Chrome	\$160			
C1	Hard Floor	\$0	B12	28" Black	\$110			
C2	Glides	\$0	B20	25" Spider Ring w/Glides	\$145			
C3	Occupied Braking	\$185		<i>Special shipping required</i>				
C4	Unoccupied Braking	\$60						

Footrings for stool cylinders only

R1	18" Black Plastic	\$60
R2	20" Chrome	\$80

NeXtep® for stool cylinders only

R8	8" w/Casters	\$185
R10	10" w/Casters	\$185
R18	8"/10" w/Casters	\$295
RW8	Wide 8" w/Casters	\$295
RW10	Wide 10" w/Casters	\$295

Also available w/glides.

For additional stool options see page 110.

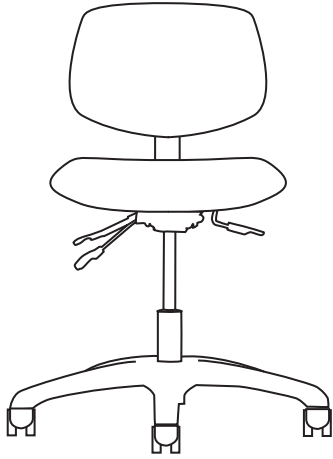

NCU552

Industrial/Healthcare

Features

- Passive weight dispersion design
- Urethane is resilient to harsh environments
- Wide variety of stool options
- Cleanroom option available

Standard Features

- No Arms
- Hard Floor Casters
- 26" Black Base
- 5" Cylinder

Step 1 — Model Number

Series Code	Back	Seat	Select a Mech
NCU Graphite	5 Flat Urethane Back	5 Flat Urethane Seat	1 Basic 2 Standard 3 Deluxe-tilt
NCU	5	5	2

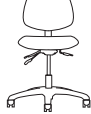
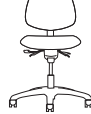
Basic	Standard	Deluxe-tilt
		
NCU551	NCU552	NCU553
\$479	\$541	\$571

Urethane

33.5 x 26 x 26	31.5 x 26 x 26	31.5 x 26 x 26	Chair (H x W x D)
41 lbs	41 lbs	41 lbs	Chair Weight
19	19	19	Seat Width
14.25 – 19.25	14 – 19	14 – 19	Seat Height
17.5 – 20	18	18	Seat Depth
R5°	R5°	F7° – R4°	Seat Angle
17	17	17	Back Width
16.25	14.5 – 18.5	14.5 – 18.5	Back Height
103°	90° – 120°	105° – 136°	Back Angle
16 – 20	16 – 20	16 – 20	Lumbar Range
26	26	26	Base Diameter
28 x 26 x 24	28 x 26 x 24	28 x 26 x 24	Shipping Box (L x W x H)
51 lbs	51 lbs	51 lbs	Shipping Weight
KD	KD	KD	Shipping Method

All measurements are nominal and shown in inches. Specs may differ for stools.

Step 2 — Add option codes after model number NCU552 - __ - __

Stool Options

General	Casters/Glides	Bases	Stool Cylinders
CR Cleanroom to Class 100 \$70	C2 Glides \$0	B3 26" Spider Ring w/Glides \$140 <i>Special shipping required</i>	L4 8" Cylinder \$55
F Fring® Footrest \$50 <i>Only available on (B0) base</i>	C3 Occupied Braking \$185	B6 26" Polished Aluminum \$140	L5 10" Cylinder \$55
HD Heavy Duty \$100 <i>Only available on (1) Mech</i>	C4 Unoccupied Braking \$60	B9 28" Chrome \$160	L7 7" Cylinder \$55
		B12 28" Black \$110	Footrings for stool cylinders only
		B20 25" Spider Ring w/Glides \$145 <i>Special shipping required</i>	R1 18" Black Plastic \$60
			R2 20" Chrome \$80
Arms		Chair Cylinders	NeXtep® for stool cylinders only
A0 4" Adjustable \$140		L1 3" Cylinder \$0	R8 8" w/Casters \$185
A2 T Arms \$90		L13 7" Dual Stage \$55	R10 10" w/Casters \$185
A3 3" Adjustable \$90		L14 10" Dual Stage \$55	R18 8"/10" w/Casters \$295
A6 4" Adjustable Extended Height \$190			RW8 Wide 8" w/Casters \$295
			RW10 Wide 10" w/Casters \$295

Also available w/glides.

For additional stool options see page 110.

Stratus™ Upholstered

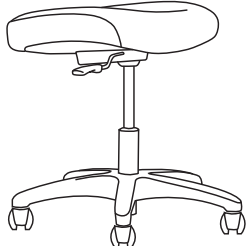

NBF064



NBF074

Features

- ESD & Cleanroom options available
- Passive weight dispersion design
- Generous foam for optimal comfort





Standard Features

- Hard Floor Casters
- 22" Black Base
- 5" Cylinder

Industrial/Healthcare

Step 1 — Model Number

Series Code	Back	Select a Seat	Select a Mech
NBF Stratus Upholstered	0 Backless	6 Medium Seat 7 Round Seat	4 Basic 5 Ring 6 Tilt
NBF	0	6	6 

Basic		Ring	Tilt
			
NBF064	NBF074	NBF075	NBF066
\$316	\$265	\$296	\$418
\$346	\$295	\$326	\$448
\$376	\$325	\$356	\$478
\$416	\$365	\$396	\$518
\$456	\$405	\$436	\$558
\$506	\$455	\$486	\$608
\$556	\$505	\$536	\$658
\$616	\$565	\$596	\$718
\$676	\$625	\$656	\$778

- Grade 1
- Grade 2
- Grade 3
- Grade 4
- Grade 5
- Grade 6
- Grade 7
- Grade 8
- Grade 9

17 x 22 x 22	16 x 22 x 22	16 x 22 x 22	19 x 22 x 22	Chair (H x W x D)
16.5 lbs	14 lbs	14 lbs	23.5 lbs	Chair Weight
19.5	16	16	19.5	Seat Width
14.5 – 19.5	16 – 21	16 – 21	15.75 – 20.75	Seat Height
18.5	16	16	18.5	Seat Depth
F4.4°	N/A	N/A	F4.7° – R21.3°	Seat Angle
22	22	22	22	Base Diameter
1 yd	1 yd	1 yd	1 yd	COM Yardage
28 x 26 x 24	25 x 25 x 11	25 x 25 x 11	28 x 26 x 24	Shipping Box (L x W x H)
26.5 lbs	24 lbs	24 lbs	33.5 lbs	Shipping Weight
KD	KD	KD	KD	Shipping Method

All measurements are nominal and shown in inches.
Specs may differ for stools.

Step 2 — Add option codes after model number NBF066 - __ - __

General		Bases	
CR Cleanroom to Class 100	\$120	B0 26" Black	\$0
E ESD*	\$290	B3 26" Spider Ring w/Glides	\$140
F Fring® Footrest	\$50	<i>Special shipping required</i>	
<i>Only available on (B0) base</i>		B6 26" Polished Aluminum	\$140
		B9 28" Chrome	\$160
		B12 28" Black	\$110
		B20 25" Spider Ring w/Glides	\$145
		<i>Special shipping required</i>	
		B22 22" Black	\$0
Casters/Glides		Chair Cylinders	
C1 Hard Floor	\$0	L1 3" Cylinder	\$0
C2 Glides	\$0	L3 5" Cylinder	\$0
C3 Occupied Braking	\$185	L13 7" Dual Stage	\$55
C4 Unoccupied Braking	\$60	L14 10" Dual Stage	\$55
C5 Single Wheel Industrial	\$60		
<i>Hard floor</i>			

Connexion® Arm	
Z1 Connexion Arm	\$350
<i>Only available on (7) seat</i>	
Connexion® Arm Attachments	
A1 Tablet Holder	\$149
<i>Requires (Z1) Connexion Arm</i>	

Stool Options

Stool Cylinders	
L4 8" Cylinder	\$55
L5 10" Cylinder	\$55
L7 7" Cylinder	\$55
Footrings for stool cylinders only	
R1 18" Black Plastic	\$60
R2 20" Chrome	\$80
NeXtep® for stool cylinders only	
R8 8" w/Casters	\$185
R10 10" w/Casters	\$185
R18 8"/10" w/Casters	\$295
RW8 Wide 8" w/Casters	\$295
RW10 Wide 10" w/Casters	\$295
<i>Also available w/glides.</i>	

For additional stool options see page 110.

*Contact Customer Service – customerservice@neutralposture.com

Stratus™ Urethane

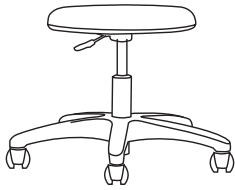

NBU044

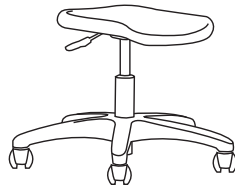

NBU054

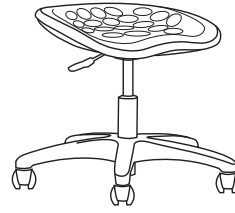

NBU084

Features



- Passive weight dispersion design
- Urethane is resilient to harsh environments
- Cleanroom option available

Standard Features

- 5" Cylinder
- 22" Black Base
- Hard Floor Casters

Industrial/Healthcare

Step 1 — Model Number







Series Code	Back	Select a Seat	Select a Mech
NBU Stratus Urethane	0 Backless	4 Round Seat 5 Flat Seat 8 Tractor Seat	4 Basic  5 Ring  6 Tilt 
NBU	0	4	6

Basic

Ring

Tilt

Stratus™ Urethane

Basic		Ring		Tilt	
					
NBU044	NBU054	NBU084	NBU045	NBU056	NBU086
\$204	\$326	\$357	\$235	\$428	\$459
13.5 x 22 x 22	14.5 x 22 x 22	13.5 x 22 x 22	13.5 x 22 x 22	15 x 22 x 22	13.25 x 22 x 22
17 lbs	28 lbs	22 lbs	17 lbs	28 lbs	22 lbs
14	19	19	14	19	19
13.5 – 18.5	14.5 – 19.5	13.5 – 18.5	13.5 – 18.5	15 – 20	13.25 – 18.25
14	18	13.5	14	18	13.5
R0°	R7°	R2.5°	R0°	F2° – R14°	F2.5° – R10°
22	22	22	22	22	22
N/A	N/A	N/A	N/A	N/A	N/A
25 x 25 x 11	25 x 25 x 11	25 x 25 x 11	25 x 25 x 11	25 x 25 x 11	25 x 25 x 11
27 lbs	38 lbs	32 lbs	27 lbs	38 lbs	32 lbs
KD	KD	KD	KD	KD	KD

Urethane

Chair (H x W x D)

Chair Weight

Seat Width

Seat Height

Seat Depth

Seat Angle

Base Diameter

COM Yardage

Shipping Box (L x W x H)

Shipping Weight

Shipping Method

All measurements are nominal and shown in inches.
Specs may differ for stools.

Step 2 — Add option codes after model number NBU046 - ___ - ___

Stool Options

General

CR	Cleanroom to Class 100	\$70
F	Fring® Footrest	\$50

Only available on (B0) base

Casters/Glides

C1	Hard Floor	\$0
C2	Glides	\$0
C3	Occupied Braking	\$185
C4	Unoccupied Braking	\$60
C5	Single Wheel Industrial	\$60

Hard floor

Bases

B0	26" Black	\$0
B3	26" Spider Ring w/Glides	\$140

Special shipping required

B6	26" Polished Aluminum	\$140
B9	28" Chrome	\$160
B12	28" Black	\$110
B20	25" Spider Ring w/Glides	\$145

Special shipping required

B22	22" Black	\$0
------------	------------------	------------

Chair Cylinders

L1	3" Cylinder	\$0
L3	5" Cylinder	\$0
L13	7" Dual Stage	\$55
L14	10" Dual Stage	\$55

Stool Cylinders

L4	8" Cylinder	\$55
L5	10" Cylinder	\$55
L7	7" Cylinder	\$55

Footrings for stool cylinders only

R1	18" Black Plastic	\$60
R2	20" Chrome	\$80

NeXtep® for stool cylinders only

R8	8" w/Casters	\$185
R10	10" w/Casters	\$185
R18	8"/10" w/Casters	\$295
RW8	Wide 8" w/Casters	\$295
RW10	Wide 10" w/Casters	\$295

Also available w/glides.

For additional stool options
see page 110.

NEXTEP®

- Adjustable depth (13", 15" & 17") from cylinder
Not available on Wide NeXtep
- Wide platform for comfortable & ergonomic positioning of the feet & leg support
- Strong, stable step for entering & exiting the stool
- Casters lock when weight is applied
- Supports up to 400 lbs

Only available on Neutral Posture stools

		w/Glides	w/Locking Casters	
8"	R7	\$135	R8	\$185
10"	R9	\$135	R10	\$185
12"	R11	\$135	R12	\$185
8"/10" Combo	R17	\$235	R18	\$295
10"/12" Combo	R21	\$235	R22	\$295
Wide 8"	RW7	\$235	RW8	\$295
Wide 10"	RW9	\$235	RW10	\$295

The NeXtep should only be used on stools that meet the current BIFMA tip test standards.

R8

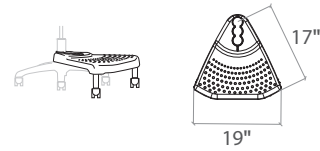

R18

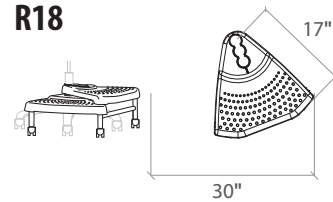

RW10

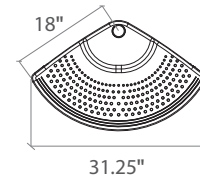

N-POSITION™

- Wide platform for comfortable & ergonomic positioning of the feet & leg support
- Top surface provides extra raised surface area to support legs while sitting
- Supports up to 400 lbs

F8 (8" Platform) \$395

F10 (10" Platform) \$395

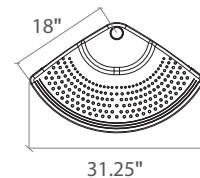
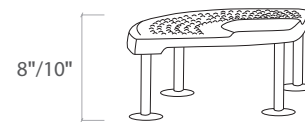

FOOTRINGS

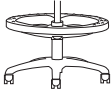

- 18" BLACK PLASTIC**
- Flat textured surface
 - Height adjustable
 - Pressure fit

R1 \$60

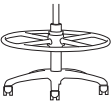

- 20" CHROME**
- Height adjustable
 - Twist/spin tightening

R2 \$80



- FRING® W/BASE**
- Aids shorter workers with a slightly higher "floor"
 - Raised massage bumps provide a gentle rub to shoeless feet

FRF \$175

FOOTRESTS

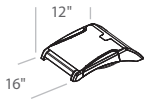

- ADJUSTABLE**
- Easy adjustment, folding support legs provide platform
 - Tilt angles of 6°, 12°, 16° & 25°
 - Provides support for workers under 5th percentile
 - Footrest surface covered by anti-fatigue rubber mat

FR16 \$175

WORKPLACE ACCESSORIES

At Neutral Posture we are about more than just chairs. The office is all about being a place where you can be productive and get your task done with excellence and speed. In order to be the most productive you can be you need accessories to help. Nothing is worse than not having the right tool when you are trying to

complete a task. People of all industries work hard and our accessories collection is here to make life just a little bit easier. From our popular Connexion Arm®, that supports your tablet, to our monitor arms, our accessories are ground-breaking and will elevate your productivity to the next level with ease.

WORKPLACE ACCESSORIES

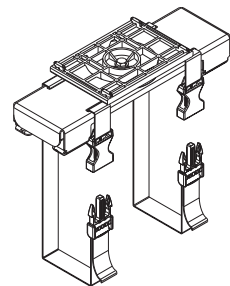
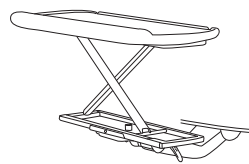
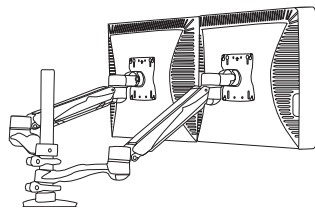
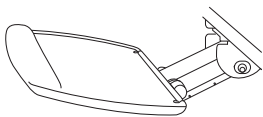

KEYBOARD ARMS



	Leverless	Sit/Stand	Econo	Dual Indicator HFES compliant	Ascension
Code	A	C	E	U	T
Leverless Height	✓	✓	N/A	N/A	✓
Height	-6" – 2.5"	-6" – 8"	-5.25" – 0"	-6.5" – 2.38"	-8" – 14"
Tilt	-15° – 0°	-15° – 0°	-15° – 15°	-20° – 10°	-15° – 10°
Spring Assist	✓	✓	✓	✓	✓
360° Rear Swivel	✓	✓	✓	✓	✓
Track Length	23"	21"	18"	19"	21"
(OPTIONAL) Short Track	18"	18"	N/A	N/A	18"
Glide Track	✓	✓	✓	✓	✓
Quick Ship	QS	QS	QS		
List	\$210	\$230	\$160	\$245	\$377

KEYBOARD TRAYS

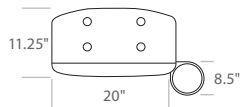

- 11**
- Straights, corners & natural keyboards
 - Anti-skid neoprene pads hold keyboard securely in place

List \$155

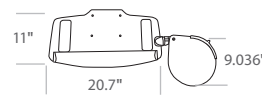

- 52**
- Straight
 - 20" "green" tray
 - Height adjustable tilt & swivel mouse
 - Gel filled palm rest

List \$325

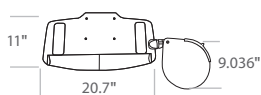

- 21**
- Straight
 - 20" phenolic tray
 - Height adjustable tilt & swivel mouse
 - Gel filled palm rest

List \$325

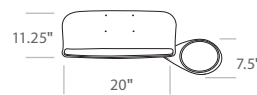

- 86 — ELEMENTAL®**
- Straights, corners and natural keyboards
 - Made from 100% recycled aluminum
 - Polished surface

List \$295

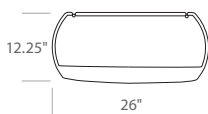

- 43 — SOFTOUCH™**
- Straight
 - Urethane over steel plate
 - Includes mouse surface

List \$230



ASCENSION — SIT TO STAND KEYBOARD ARM

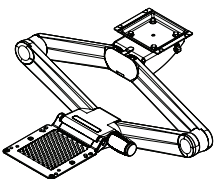

- T — ASCENSION ARM**
- Low profile arm and tray head
 - Concealed hardware
 - Clear access to tilt control knob

List \$377

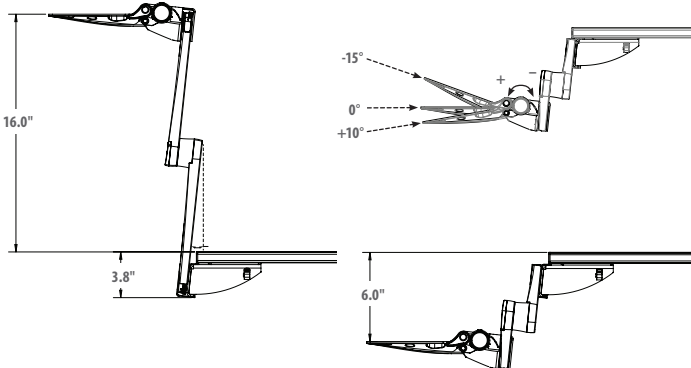
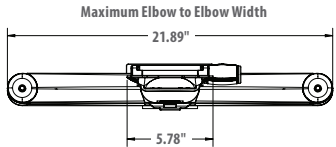

EASY COMBOS

Keyboard Arms

Keyboard Trays	Keyboard Arms				
	Leverless (A)	Sit/Stand (C)	Econo (E)	Dual Indicator (U)	Ascension (T)
11	Easy A11 \$365	Easy C11 \$385	Easy E11 \$315	Easy U11 \$400	Easy T11 \$532
21	Easy A21 \$535	Easy C21 \$555	Easy E21 \$485	Easy U21 \$570	Easy T21 \$702
43 – SofTouch™	Easy A43 \$440	Easy C43 \$460	Easy E43 \$390	Easy U43 \$475	Easy T43 \$607
52	Easy A52 \$535	Easy C52 \$555	Easy E52 \$485	Easy U52 \$570	Easy T52 \$702
86 – elementAI®	Easy A86 \$505	Easy C86 \$525	Easy E86 \$455	Easy U86 \$540	Easy T86 \$672

Easy Combo Options

General

- 5 **Short Track – 18"** \$0
Only available on (A) or (C) arm

Workplace Accessories

Workplace Accessories

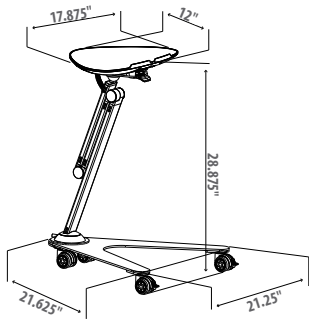

MONITOR ARMS

ROVI™

- Alleviate pain and facilitate healthy posture while providing hands free support for print or electronic media
- Universal Design
- White Board
- Optional LED Light
- Integrated Charging Cable for Apple & Android Devices
- Extra USB Port
- Easy to Clean with Commercial & Hospital Grade Solutions
- Seated to Standing/Adjust to the Perfect Position
- Solutions ideal for laptop, tablets, phones and traditional media
- Integrate digital tools into learning and collaborative environments
- Convert a workspace easily between one employee today and another tomorrow in the same office
- Sleekly augment any office space and every workspace, ensuring that everyone in that space can utilize their mobile device in an ergonomically supportive way

Mobile Stand	List
ROV-55-TS-RS	\$950
Desktop	List
ROV-55-DM	\$700
Head Only	List
ROV-55-MM	\$450

ROVI ACCESSORIES

Extra Magnetic Tablet Pad	List
ROV-TAB-PAD	\$35
Extra Magnetic Phone Pad	List
ROV-PH-PAD	\$47
iPhone 6/7 Magnetic Case	List
ROV-IPH-CASE	\$47
USB LED Light	List
ROV-LGHT	\$47

MONITOR ARMS

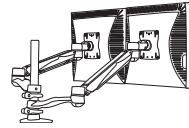

BOOST™ MONITOR ARM

- Yields 13" of vertical movement & 24" of extension
- Supports monitors weighing up to 20 lbs
- Effortlessly position two monitors at the same height on a single post
- Easily attach two arms on a single post without additional brackets
- Install three or more arms with an optional cross bar
- Convenient keyhole slots to effortlessly install monitor onto mounting plate
- Panel, slat wall & desk mounting options

NOTE: For multi-screen solutions, contact customerservice@neutralposture.com

Single Arm	Description	List
KCG-110B	Black	\$455
KCG-110S	Silver	\$455
Double Arm		List
KCG-110DB	Black	\$899
KCG-110DS	Silver	\$899
Wall Mount		List
KCG-WMB	Black	\$525
KCG-WMS	Silver	\$525

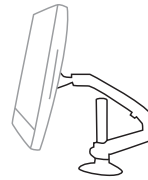

FREEDOM ARM

- Includes vesa plate aluminum articulating arm & desk clamp base
- Tilt: Up 90°, Down 45°
- Pan: 180°
- Rotation: 360°
- Offers 14" of dynamic one-touch height adjustment
- Full extension range of 23.4"

Model #	Description	List
918001	Silver	\$495

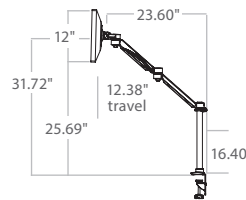

SIT/STAND MONITOR ARM

- Sturdy aluminum construction with vesa compatibility
- Width & depth adjustable fasteners
- Convenient pull handle
- Brings monitor up to standing height

Model #	Description	List
KCG-SSB	Black	\$575
KCG-SSS	Silver	\$575

ACCESSORIES

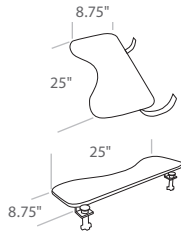

FOREARM SUPPORTS

- Alleviates shoulder, neck & body burden
- Provides soft transition to protect ulnar nerve
- Lightweight & portable



Model 1	Model 2	
160241 \$240	160243 \$240	w/Hooks
160242 \$240	160244 \$240	w/Screws

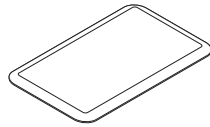

ANTI-FATIGUE FLOOR MATS

- Premium comfort will not bottom out or lose bounce over time
- Commercial-grade heavy-duty polyurethane
- Matte texture provides optimum traction
- Beveled edge reduces tripping potential
- Available in black

H	W	D	MODEL #	LIST
¾"	32"	20"	EAM3220B	\$285
¾"	48"	20"	EAM4820B	\$435
¾"	72"	20"	EAM7220B	\$648
¾"	36"	24"	EAM3624B	\$360
¾"	60"	36"	EAM6036B	\$828

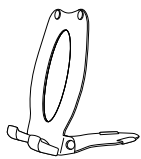

TABLET HOLDER

- Light weight & portable
- Dimensions: 6.76 x 5.5 x 2
- Holds tablets, phones or documents upright
- Easily adjusts for comfortable viewing angle
- Rests on desktop or flat surfaces

Model #	Description	List
TABHLDR	Black	\$137

CPU HOLDERS

CPU HOLDER

- Mounts easily under worksurface storing CPU safely under desk & off the floor
- Adjusts to either a vertical or horizontal position
- Adjustable width of 5.5" – 9.8" & height of 15.5" – 20"

Model #	List
VCPUF	\$175

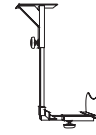

CPU HOLDER

- CPU retracts on a 17" track & swivels to allow full accessibility & easy storage
- Accommodates CPU weighing up to 75 lbs & measuring 64" in perimeter
- Installation is quick & easy
- Soft touch anti-slip pads prevent CPU from slipping

Model #	List
VCPU	\$195

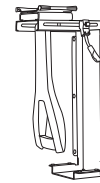

ADJUSTABLE HEIGHT TABLES

For adjustable height tables see Equity^{NP} Price List

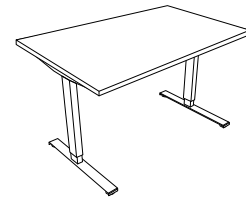

Workplace Accessories



STANDUP®

- Retrofits between most existing keyboard trays & keyboard arms
- Mounts directly to worksurface without keyboard arm
- Additional 2" – 11" of height adjustment
- Infinite range positioning
- \$50 discount when ordered with any Easy Combo (page 115)

MODEL #	LIST
SUP04	\$420

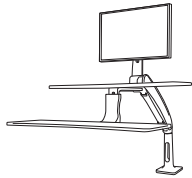

STANDUP® A1

- The integral dual tray system offers a spacious keyboard & mouse platform as well as a secondary surface for other items
- Extends forward to allow the keyboard tray to rest below the desk surface supporting proper ergonomic positioning
- Over 22" of assisted positioning
- Accommodates users ranging from 5th percentile seated female to 95th percentile standing male
- Supports monitors weighing between 5–20 lbs
- Supports technology ranging from 5–25 lbs
- Grommet or clamp mount

1 MONITOR	MECH	LIST
SUPA1B	Black	\$997
SUPA1S	Silver	\$997

2 MONITORS	MECH	LIST
SUPA2B	Black	\$1,187
SUPA2S	Silver	\$1,187

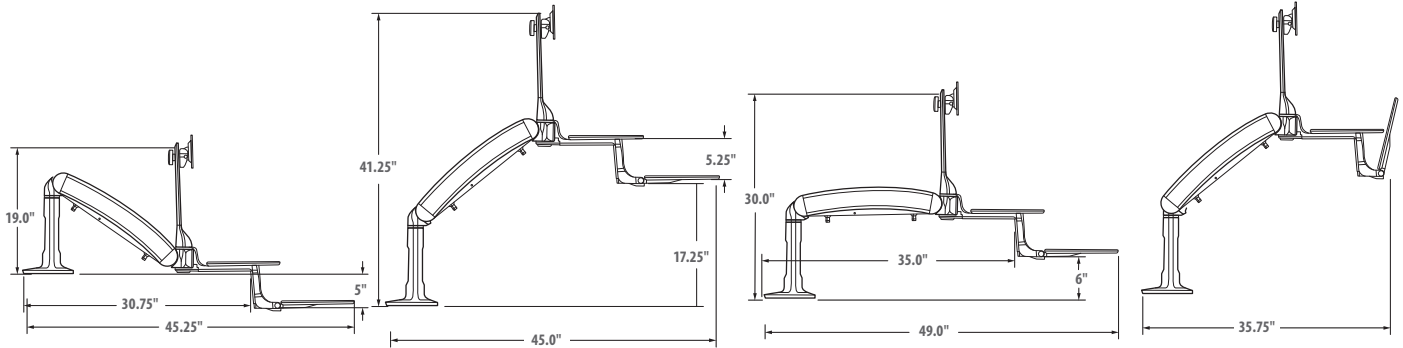
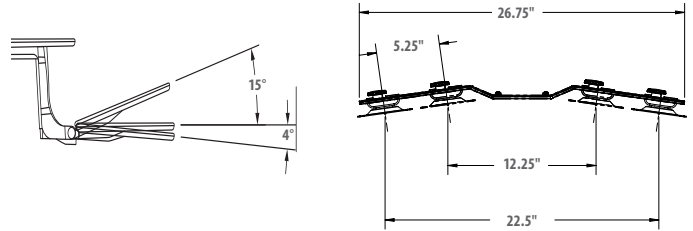

GROMMET MOUNT

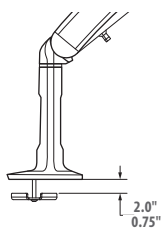

CLAMP MOUNT

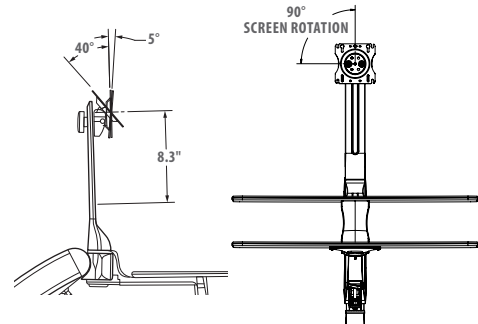
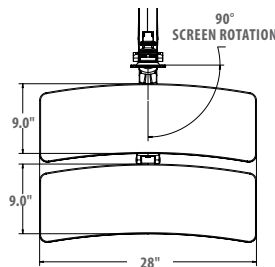
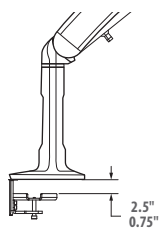

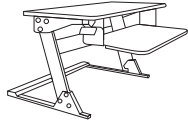

STANDUP® X1

- Easily convert any desk into a sit/stand workstation
- 13.8" of height range accommodates a variety of users
- Keyboard tray has 20° (-10° to 10°) of tilt
- Weighs only 40 lbs
- Primary worksurface accommodates two 24" monitors
- No assembly required

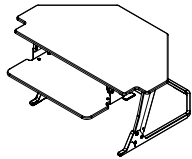
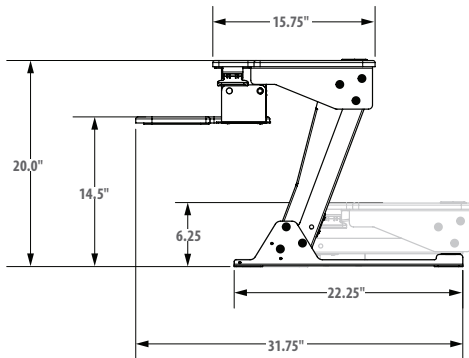

STANDUP® X1 — CORNER

- Easily convert any desk into a sit/stand workstation
- Designed to fit 90° corner desk configurations
- 13.8" of height range accommodates a variety of users
- Keyboard tray has 20° (-10° to 10°) of tilt
- Weighs only 42 lbs
- Primary worksurface accommodates two 24" monitors
- No assembly required

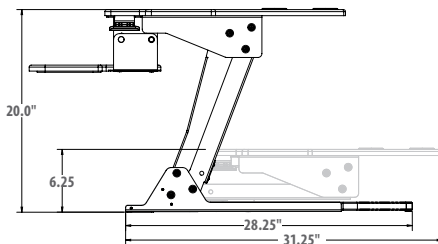

36" Wide — Supports up to 35 lbs

MODEL #	MECH	WORKSURFACE	LIST/L1	L2	L3
SUPX136B	Black	N/A	\$ 567	N/A	N/A
SUPX136BL	Black	Laminate	\$ 897	\$ 987	\$ 1,076
SUPX136W	White	N/A	\$ 567	N/A	N/A
SUPX136WL	White	Laminate	\$ 897	\$ 987	\$ 1,076

40" Wide — Supports up to 35 lbs

MODEL #	MECH	WORKSURFACE	LIST/L1	L2	L3
SUPX140BL	Black	Laminate	\$ 955	\$ 1,051	\$ 1,146
SUPX140WL	White	Laminate	\$ 975	\$ 1,073	\$ 1,170

42" Wide — Supports up to 45 lbs

MODEL #	MECH	WORKSURFACE	LIST/L1	L2	L3
SUPX142B	Black	N/A	\$ 975	N/A	N/A
SUPX142BL	Black	Laminate	\$ 995	\$ 1,095	\$ 1,194

48" Wide — Supports up to 45 lbs

MODEL #	MECH	WORKSURFACE	LIST/L1	L2	L3
SUPX148BL	Black	Laminate	\$ 1,175	\$ 1,293	\$ 1,410

36" Wide — Supports up to 35 lbs

MODEL #	MECH	WORKSURFACE	LIST/L1	L2	L3
SUPX1CR36BL	Black	Laminate	\$ 1,365	\$ 1,502	\$ 1,638

42" Wide — Supports up to 35 lbs

MODEL #	MECH	WORKSURFACE	LIST/L1	L2	L3
SUPX1CR42B	Black	N/A	\$ 995	N/A	N/A
SUPX1CR42BL	Black	Laminate	\$ 1,395	\$ 1,535	\$ 1,674

LAMINATES FOR STANDUP X1

L1

Ebony Starlight – Surf(x)
Matte White – Surf(x)

3D-100
3D-200

L2

American Natural – Surf(x)
Baroque – 3D
Hayward Cherry – Surf(x)
Shaker Cherry – Surf(x)

3D-300
3D-600
3D-400
3D-500

L3

All other laminates from Omnova are available at L3 pricing with a minimum order of 10 StandUp X1s.

<https://www.omnova.com/product-types/laminates>

FABRICS

Grade 1

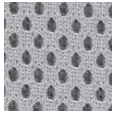

Spacer
Mayer Fabrics
1,000,000+ double rubs

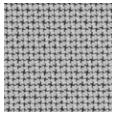

Cross Check
Mayer Fabrics
258,000 double rubs

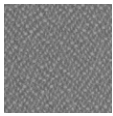

Forte
Mayer Fabrics
183,000 double rubs

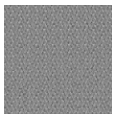

Quattro
Mayer Fabrics
237,000 double rubs

Grade 2

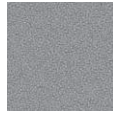

Ace
C.F. Stinson
1,000,000+ double rubs
Not available on NV (3) back

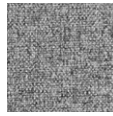

Fedora
Mayer Fabrics
100,000 double rubs

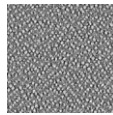

Foundation 10
Mayer Fabrics
1,000,000 double rubs

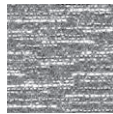

Fuse
Momentum Textiles
100,000 double rubs

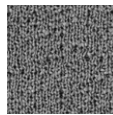

M Plus
Teknit®
200,000 double rubs
Not available on Embrace, Embrace Guest & NV

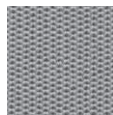

Top Shelf
Guilford of Maine
250,000 double rubs
Not available on Embrace, Embrace Guest & NV

Grade 3

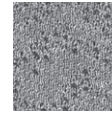

Cloud 9™
335,000 double rubs
Not available on Embrace, Embrace Guest & NV

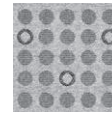

Knack
Momentum Textiles
100,000 double rubs

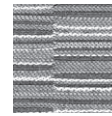

Lineup
Momentum Textiles
100,000 double rubs

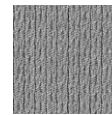

Moonscape
Mayer Fabrics
378,000 double rubs



Reverb
Mayer Fabrics
100,000+ double rubs

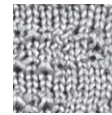

Revive™
Teknit®
125,000 double rubs
Not available on Embrace, Embrace Guest & NV

CAL 133

Grade 2

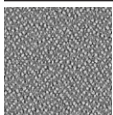

Foundation 10
Mayer Fabrics
1,000,000 double rubs

Grade 4



Avant
C.F. Stinson
1,500,000 double rubs

Grade 5

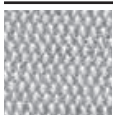

Messenger
Maharam
100,000 double rubs

ESD

Grade 5

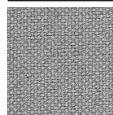

Nylon Stat
Mayer Fabrics
138,000 double rubs



Vinyl Stat - ESD
Mayer Fabrics
100,000 double rubs

CRYPTON

Grade 5

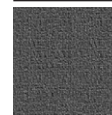

Finale
Mayer Fabrics
250,000 double rubs

LEATHERS/FAUX LEATHERS

Grade 1

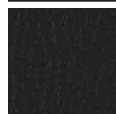

Ranchero
Mayer
250,000 double rubs

Grade 2

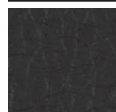

Dolce (Black Only)
Spradling International
400,000 double rubs

Grade 3



Primera®
Ultrafabrics®
400,000 double rubs



Nauga Soft
Mosehart-Schleeter
1,000,000 double rubs

Grade 5

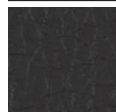

Canter EPU (*anti-microbial*)
Momentum Textiles
1,000,000 double rubs



Dolce (Colors)
Spradling International
400,000 double rubs



Ultraleather™
Ultrafabrics®
400,000 double rubs

Grade 9

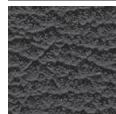

Madras
335,000 double rubs

QUICK SHIP FABRICS

Grade 1

Ranchero	Black	230609
Spacer	Pewter	200651
Spacer	Ink	200649
Spacer	Black	200648
Spacer	Wine	200650

Grade 2

Ace	Toast	200714
Ace	Peony	200710
Ace	Char	200703
Ace	Midnight	200709
Ace	Jet	200707

Grade 3

Cloud 9	Red Dawn
Cloud 9	Midnight Sky
Cloud 9	New Haze
Cloud 9	Fog
Cloud 9	Thunder
Revive	Ebony
Revive	Goose
Revive	Ink
Revive	Metal

Graded In Fabrics

GRADED IN AND COM UPHOLSTERY

Neutral Posture's furniture is manufactured to the highest standards. The unique nature of upholstery and the other materials that are used in production means that no two pieces will be exactly alike. Fabrics will upholster differently based on composition and construction. Neutral Posture makes every effort to ensure that each item is produced to our exacting standards, but cannot be held responsible for slight variations in upholstery, color and general appearance.

Our artisans are skilled in creating consistent finishes across all products and materials. However, the individual nature of the materials used in the construction of our furniture means that no two pieces of furniture are exactly alike. Similarly, the images in our publications are as accurate as your monitor is calibrated, but customers are reminded that colors and finishes may vary according to the unique nature of each item of furniture.

Neutral Posture will not be responsible for variances in the sit and performance of a chair due to the fact that certain fabrics such as knits will perform differently than milled fabrics. Generally, knitted fabrics will create a softer sit and milled fabrics will provide a firmer sit.

For specific color matching requirements please contact Customer Service.

The Neutral Posture Upholstery Department is pleased to offer a Graded-in program and also accepts C.O.M. for most products. For certain items or in cases of unusual or difficult fabric patterns additional material may be required. Any unusual or special cutting requirements must be requested in writing and a full-width fabric repeat sent to Customer Service in order for a quotation to be provided. The customer is responsible for shipping C.O.M. to our Upholstery Department.

ARC COM		
Manufacturer	Pattern	Grade
Arc Com	Allegra	5
Arc Com	Alpha	5
Arc Com	Analog	7
Arc Com	Apex	6
Arc Com	Arashi	7
Arc Com	Astral	6
Arc Com	Atomic	6
Arc Com	Aurora	6
Arc Com	Axis	6
Arc Com	Bali	7
Arc Com	Beat Box	6
Arc Com	Block Party	7
Arc Com	Block Petal	6
Arc Com	Blossom	6
Arc Com	Boardwalk	5
Arc Com	Bounce 2	7
Arc Com	Brayer Flower	7
Arc Com	Bronco	5
Arc Com	Bubbly	6
Arc Com	Campus Stripe	6
Arc Com	Candy Land	7
Arc Com	Carnival	5
Arc Com	Casablanca	6
Arc Com	Cascade	6
Arc Com	Cassio	5
Arc Com	Centring Stripe	6
Arc Com	Channel	5
Arc Com	Chit-Chat	5
Arc Com	Chroma	5
Arc Com	Cirque	7
Arc Com	Clarion	6
Arc Com	Coastline	5
Arc Com	Column	5
Arc Com	Compass	6
Arc Com	Constantine	8
Arc Com	Contour	5
Arc Com	Cosmos	5
Arc Com	Crossroads	6
Arc Com	Crystal	5
Arc Com	Dakota	5
Arc Com	Dakota 2	5
Arc Com	Daytona	7
Arc Com	Dazzle	8
Arc Com	Delphi	5
Arc Com	Delta	5
Arc Com	Durango 2	4
Arc Com	Dynasty	6
Arc Com	Echo 2	6
Arc Com	Eclipse	6
Arc Com	Elementary	7
Arc Com	Elevado	6
Arc Com	empress	5
Arc Com	Etch	5
Arc Com	Facet	6
Arc Com	Fiji	5
Arc Com	Fiore	7
Arc Com	Fireflies	5
Arc Com	Francesca Wool	7

Manufacturer	Pattern	Grade
Arc Com	Francesca Wool II	7
Arc Com	Frontier 2	4
Arc Com	Galaxy	6
Arc Com	Gamma	5
Arc Com	Gardenia	5
Arc Com	Gatsby	5
Arc Com	Gem	5
Arc Com	Geostitch	7
Arc Com	Gianni	6
Arc Com	Glam	5
Arc Com	Glimmer	6
Arc Com	Glo	5
Arc Com	Great Wall	6
Arc Com	Grid	6
Arc Com	Hanji	6
Arc Com	Harlequin	6
Arc Com	Highlands	6
Arc Com	Hopscotch	5
Arc Com	Hush	5
Arc Com	Illusion	4
Arc Com	Illusion 2	4
Arc Com	Intaglio	6
Arc Com	Intaglio 2	6
Arc Com	Intersect	5
Arc Com	Isabella	5
Arc Com	Itajime	6
Arc Com	Jardin	6
Arc Com	Jing	5
Arc Com	Jive	5
Arc Com	Juilet 2	7
Arc Com	Katano	6
Arc Com	Key	5
Arc Com	Kimono	6
Arc Com	Kinetic	6
Arc Com	Kirgami	6
Arc Com	Kuba	6
Arc Com	Kumo	7
Arc Com	Laurel 2	6
Arc Com	Legacy	6
Arc Com	Legend	6
Arc Com	Leonardo	5
Arc Com	Linea	6
Arc Com	Loara	6
Arc Com	Lore	6
Arc Com	Lotus	5
Arc Com	Lunette	7
Arc Com	Luxe	6
Arc Com	Lyre	5
Arc Com	Lyric	6
Arc Com	Majorca	6
Arc Com	Marathon	5
Arc Com	Marquee	6
Arc Com	Mason	6
Arc Com	Mason Stripe	6
Arc Com	Meadow	6
Arc Com	Meridan	4
Arc Com	Mesa	5
Arc Com	Metro	7
Arc Com	Mirror Mirror	6

Manufacturer	Pattern	Grade	Manufacturer	Pattern	Grade	Manufacturer	Pattern	Grade
Arc Com	Moon Beam	6	Arc Com	Spin	7	Carnegie	Carnival	8
Arc Com	Moon Beam 2	6	Arc Com	Spirit	5	Carnegie	Cascade Applique S	Call
Arc Com	Morocco	6	Arc Com	Spot On	6	Carnegie	Channel	5
Arc Com	Mystique	6	Arc Com	Spring	6	Carnegie	Chelsea	5
Arc Com	Navigator	6	Arc Com	Spyro	6	Carnegie	Chroma	9
Arc Com	Network	8	Arc Com	Square One	7	Carnegie	Circuit S	6
Arc Com	Niagara	6	Arc Com	Strand-It	7	Carnegie	Cirque Couture	Call
Arc Com	Nova	6	Arc Com	Strata	5	Carnegie	Coco Couture	7
Arc Com	Oasis	7	Arc Com	Streamline	5	Carnegie	Collage	7
Arc Com	Oculus	6	Arc Com	Sundial	6	Carnegie	Cross Stitch	9
Arc Com	Odyssey	5	Arc Com	Symphony	6	Carnegie	Crossing	6
Arc Com	Ombre Petal	6	Arc Com	Sync	5	Carnegie	Cycle X	6
Arc Com	Omega	5	Arc Com	Tally	5	Carnegie	Dash X	6
Arc Com	Orion	5	Arc Com	Tectonic	5	Carnegie	Dawn	5
Arc Com	Pala	7	Arc Com	The Plaid	8	Carnegie	Dazzle	8
Arc Com	Palatine	5	Arc Com	Theory	3	Carnegie	Deco Embroider S	9
Arc Com	Palatine 2	5	Arc Com	Top Notch	Call	Carnegie	Departure	5
Arc Com	Panache	5	Arc Com	Tritik	6	Carnegie	Edge	6
Arc Com	Pebble Beach	5	Arc Com	Uptown	7	Carnegie	Elite	3
Arc Com	Pinball	6	Arc Com	Urban	6	Carnegie	Fine Line	7
Arc Com	Pinpoint	6	Arc Com	Vault	6	Carnegie	Flash Back S	6
Arc Com	Plateau	5	Arc Com	Velocity	6	Carnegie	Flex	5
Arc Com	Polished	6	Arc Com	Vineyard	6	Carnegie	Flux X	6
Arc Com	Polo	6	Arc Com	Vista	5	Carnegie	Four Square	7
Arc Com	Posh	7	Arc Com	Volt	8	Carnegie	Fractal Emboss S	6
Arc Com	Prism	4	Arc Com	Windlass	7	Carnegie	Fragment Emboss S	6
Arc Com	Provence	Call	Arc Com	Yo-Yo	7	Carnegie	Fresco	6
Arc Com	Quad	7	Arc Com	Zip Line	6	Carnegie	Fusion	6
Arc Com	Radius	6				Carnegie	Gamma S	5
Arc Com	Raya	6				Carnegie	Genome Embroider S	9
Arc Com	Rhythm	6				Carnegie	Groove	5
Arc Com	Ringling	6				Carnegie	Hashtag	5
Arc Com	Riviera	7				Carnegie	Havana X	6
Arc Com	Rbotic	6				Carnegie	Haze X	7
Arc Com	Rodeo	5				Carnegie	Hepburn	6
Arc Com	Rodeo 2	5				Carnegie	Herald	5
Arc Com	Rogue	6				Carnegie	Herringbone X	5
Arc Com	Roundabout	5				Carnegie	Hide	5
Arc Com	Roundabout	5				Carnegie	High Line	7
Arc Com	Sagrada	7				Carnegie	Hive	7
Arc Com	Sahara	6				Carnegie	Hoop Embroider S	8
Arc Com	Samba	6				Carnegie	Hue	6
Arc Com	Santa Fe	6				Carnegie	Icon	9
Arc Com	Santorini	6				Carnegie	Impress	5
Arc Com	Saxon	6				Carnegie	Index	4
Arc Com	Sea Willow	6				Carnegie	Infinity Plaid	8
Arc Com	Sector	6				Carnegie	Infinity Plush	8
Arc Com	Sequoia	6				Carnegie	Infinity Stripe	8
Arc Com	Sherlock	5				Carnegie	Journey	7
Arc Com	Sherlock 2	5				Carnegie	Kaleidoscope S	6
Arc Com	Shibori	6				Carnegie	Keystone	5
Arc Com	Shift	6				Carnegie	Kid	5
Arc Com	Shimmer	5				Carnegie	Kinetic	7
Arc Com	Shimmer 2	5				Carnegie	Koi	7
Arc Com	Silverado	5				Carnegie	Linen X	5
Arc Com	Silverado 2	5				Carnegie	Low Line	7
Arc Com	Solitude	6				Carnegie	Maxim	5
Arc Com	Soectrum	5				Carnegie	Maxwell Street	9
Arc Com	Speedway	6				Carnegie	Maze	7

CARNEGIE		
Manufacturer	Pattern	Grade
Carnegie	360	9
Carnegie	Abacus Embroider S	8
Carnegie	Alex	8
Carnegie	Allure	5
Carnegie	Anchor	7
Carnegie	Antoinette Couture S	7
Carnegie	Aria	Call
Carnegie	Artisan Embroider S	9
Carnegie	Axis Embroider S	8
Carnegie	Bangle	7
Carnegie	Bardot	6
Carnegie	Barre	7
Carnegie	Basket	6
Carnegie	Bauble	8
Carnegie	Bliss	7
Carnegie	Blowing Bubbles	7
Carnegie	Bolt	9
Carnegie	Break Line	9
Carnegie	Brick Lane	6
Carnegie	Brigitte Couture S	7
Carnegie	Brimfield	7
Carnegie	Buff	5
Carnegie	Buzz	7
Carnegie	Camden	7
Carnegie	Cane Embroider S	Call

Graded In Fabrics

Manufacturer	Pattern	Grade
Carnegie	Merge	6
Carnegie	Merkhet	6
Carnegie	Mesh X	6
Carnegie	Meteor X	6
Carnegie	Moire Stripe Couture S	7
Carnegie	Monocle Embroider	9
Carnegie	Monroe	6
Carnegie	Moto	6
Carnegie	Ola	Call
Carnegie	Origin	5
Carnegie	Oxford	5
Carnegie	Pivot	6
Carnegie	Pixie Applique X	Call
Carnegie	Pony	5
Carnegie	Pop Emboss X	6
Carnegie	Prime	5
Carnegie	Prism X	6
Carnegie	Quarry X	6
Carnegie	Rattan X	5
Carnegie	Reef X	5
Carnegie	Relay	9
Carnegie	Reveal	8
Carnegie	Reverie	5
Carnegie	Revolve	7
Carnegie	Rise	3
Carnegie	Roxy	5
Carnegie	Sequence X	6
Carnegie	Spark	9
Carnegie	Silhouette Embroider X	8
Carnegie	Siltech Press	7
Carnegie	Sleet Embroider X	8
Carnegie	Slide X	6
Carnegie	Spice	7
Carnegie	Spire X	6
Carnegie	Spyro Embroider X	7
Carnegie	Strata X	5
Carnegie	Stride	Call
Carnegie	Strie X	5
Carnegie	Sway Embroider S	8
Carnegie	Switch X	6
Carnegie	Switch Embroider X	8
Carnegie	Tangle	6
Carnegie	Theory	5
Carnegie	Tilt	7
Carnegie	Topiary Embroider X	9
Carnegie	Trace X	7
Carnegie	Trestle	7
Carnegie	Triad	7
Carnegie	Triad Stripe	7
Carnegie	Triathlon	7
Carnegie	Tweed S	6
Carnegie	Twine	6
Carnegie	Ultra	6
Carnegie	Veneer Emboss X	6
Carnegie	Versailles Emboss X	6
Carnegie	Verse	4
Carnegie	Vibe	6
Carnegie	Vintage	7
Carnegie	Whirlybird	7

Manufacturer	Pattern	Grade
Carnegie	Wish	7
C.F. STINSON		
Manufacturer	Pattern	Grade
C.F. Stinson	Ace	2
C.F. Stinson	Acrobat	7
C.F. Stinson	Adaigo	5
C.F. Stinson	Adirondack	6
C.F. Stinson	Aero	5
C.F. Stinson	Alchemy	5
C.F. Stinson	Alfresco	6
C.F. Stinson	Algiers	7
C.F. Stinson	Alignment	6
C.F. Stinson	Anagram	5
C.F. Stinson	Arc	5
C.F. Stinson	Artisan	4
C.F. Stinson	Atlas	3
C.F. Stinson	Avant	4
C.F. Stinson	Balance Beam	6
C.F. Stinson	Bali	6
C.F. Stinson	Bass Line	6
C.F. Stinson	Beatbox	6
C.F. Stinson	Bespoke	5
C.F. Stinson	Blip	4
C.F. Stinson	Block Party	6
C.F. Stinson	Bloom	8
C.F. Stinson	Bongo	6
C.F. Stinson	Boost w/ Celliant	6
C.F. Stinson	Borderline	6
C.F. Stinson	Breton	6
C.F. Stinson	Brilliant	4
C.F. Stinson	Broadband	6
C.F. Stinson	Bryant Park	3
C.F. Stinson	Calibration	6
C.F. Stinson	Cannon Beach	7
C.F. Stinson	Catalina	6
C.F. Stinson	Catwalk	5
C.F. Stinson	Celeste	6
C.F. Stinson	Chakra	7
C.F. Stinson	Chi w/ Agion®	7
C.F. Stinson	Cinnamon Blossom	6
C.F. Stinson	Circulate w/ Celliant	6
C.F. Stinson	Circo	6
C.F. Stinson	Coco	6
C.F. Stinson	Colden	6
C.F. Stinson	Color Black	7
C.F. Stinson	Comeback	7
C.F. Stinson	Concentric	6
C.F. Stinson	Continuum	5
C.F. Stinson	Core	3
C.F. Stinson	Cottonwood	5
C.F. Stinson	Courtyard	6
C.F. Stinson	Cozy	5
C.F. Stinson	Cranbrook Loop	Call
C.F. Stinson	Crypton Metro	5
C.F. Stinson	Crystalline	6

Manufacturer	Pattern	Grade
C.F. Stinson	Current	7
C.F. Stinson	Curves Ahead	6
C.F. Stinson	Cyma	7
C.F. Stinson	Dart	4
C.F. Stinson	Deflection	6
C.F. Stinson	Detail	5
C.F. Stinson	Deza	7
C.F. Stinson	Diffusion	7
C.F. Stinson	Division	5
C.F. Stinson	Donegal	5
C.F. Stinson	Double Time w/ Agion	7
C.F. Stinson	Duet	5
C.F. Stinson	Drizzle	7
C.F. Stinson	Elderberry	7
C.F. Stinson	Enhance w/ Celliant	6
C.F. Stinson	Equinox	5
C.F. Stinson	Euclid	4
C.F. Stinson	Fast Lane	3
C.F. Stinson	Fenestra	7
C.F. Stinson	Figment	6
C.F. Stinson	Firefly	7
C.F. Stinson	Fleck	3
C.F. Stinson	Flex	5
C.F. Stinson	Flip Flops	6
C.F. Stinson	Florentine	5
C.F. Stinson	Folio	6
C.F. Stinson	Fractal	6
C.F. Stinson	Full Tum	6
C.F. Stinson	Furrows	4
C.F. Stinson	Gradation	5
C.F. Stinson	Gravity	5
C.F. Stinson	Grove	6
C.F. Stinson	Hands On	6
C.F. Stinson	Handwork	6
C.F. Stinson	Happy Hour	5
C.F. Stinson	Happy Tappy	7
C.F. Stinson	Haven	5
C.F. Stinson	Helix	6
C.F. Stinson	Hi-Fi	4
C.F. Stinson	Highlight	4
C.F. Stinson	Hive	4
C.F. Stinson	Hot Spot	5
C.F. Stinson	Hourglass	6
C.F. Stinson	Hudson	7
C.F. Stinson	Hush	6
C.F. Stinson	I Spy	6
C.F. Stinson	Infinity Plush	7
C.F. Stinson	Inside Track	4
C.F. Stinson	Interval	5
C.F. Stinson	Isabella	6
C.F. Stinson	Jala	7
C.F. Stinson	Jam Session w/ Agion	7
C.F. Stinson	Jambi Stripe	6
C.F. Stinson	Kambala	7
C.F. Stinson	Kennebunk	6
C.F. Stinson	Ketana	6
C.F. Stinson	Kinetic	6
C.F. Stinson	Knock Knock	7
C.F. Stinson	Knot	5

Manufacturer	Pattern	Grade	Manufacturer	Pattern	Grade	C.F. STINSON VINYL		
						Manufacturer	Pattern	Grade
C.F. Stinson	Labyrinth	6	C.F. Stinson	Salinas	8	C.F. Stinson	Abacus	6
C.F. Stinson	Lateral	3	C.F. Stinson	San Simeon	7	C.F. Stinson	Affinity	6
C.F. Stinson	Leaps & Bounds	6	C.F. Stinson	Satellite	5	C.F. Stinson	Apex-Crypton® Revl™	5
C.F. Stinson	Lifecycle	7	C.F. Stinson	Scintillate	6	C.F. Stinson	Aspen	5
C.F. Stinson	Lift	7	C.F. Stinson	Seagrass	6	C.F. Stinson	Atlas	3
C.F. Stinson	Line Dance	5	C.F. Stinson	Sequence	4	C.F. Stinson	Atmosphere	4
C.F. Stinson	Links	6	C.F. Stinson	Shimmy	5	C.F. Stinson	Auberge	5
C.F. Stinson	Lucent	7	C.F. Stinson	Sideline	5	C.F. Stinson	Avant	4
C.F. Stinson	Luster	5	C.F. Stinson	Skyline	6	C.F. Stinson	Bambu-EnVi™	5
C.F. Stinson	Makeover	7	C.F. Stinson	Sleek	5	C.F. Stinson	Banyan	6
C.F. Stinson	Manchester	5	C.F. Stinson	Snuggle	5	C.F. Stinson	Bari	6
C.F. Stinson	Mandala	5	C.F. Stinson	Spindles	7	C.F. Stinson	Bistro	3
C.F. Stinson	Marimba	6	C.F. Stinson	Splash	6	C.F. Stinson	Bon Voyage	6
C.F. Stinson	Marquetry	6	C.F. Stinson	Splice	7	C.F. Stinson	Budget Black	1
C.F. Stinson	Maxwell	4	C.F. Stinson	Sprint	3	C.F. Stinson	Burkshire	4
C.F. Stinson	Maze	7	C.F. Stinson	Squire	5	C.F. Stinson	Camino	8
C.F. Stinson	Migration	7	C.F. Stinson	Stellar	5	C.F. Stinson	Capreni	5
C.F. Stinson	Mingle	6	C.F. Stinson	Steppe	6	C.F. Stinson	Carlisle	4
C.F. Stinson	Moby	3	C.F. Stinson	Stipple	5	C.F. Stinson	Casablanca	6
C.F. Stinson	Modernist	7	C.F. Stinson	Storyboard	7	C.F. Stinson	Cassidy	4
C.F. Stinson	Monhegan	6	C.F. Stinson	Straight and Narrow	6	C.F. Stinson	Catalyst	4
C.F. Stinson	Montage	5	C.F. Stinson	Stratford	8	C.F. Stinson	Channel	5
C.F. Stinson	Mumbai	7	C.F. Stinson	Sumatran Palm	6	C.F. Stinson	Chroma	5
C.F. Stinson	Nest	6	C.F. Stinson	Summit	5	C.F. Stinson	Cielo	8
C.F. Stinson	Next Scene	6	C.F. Stinson	Sunburst	6	C.F. Stinson	Cirque	5
C.F. Stinson	Nimble	6	C.F. Stinson	Sunswept	6	C.F. Stinson	Citadel	4
C.F. Stinson	Nova	5	C.F. Stinson	Supersiliness	7	C.F. Stinson	Clean Slate	5
C.F. Stinson	Now & Zen w/ Agion	7	C.F. Stinson	Swipe	6	C.F. Stinson	Colorguard	3
C.F. Stinson	Naugasoft	3	C.F. Stinson	Swivel	6	C.F. Stinson	Connect	4
C.F. Stinson	Olivia	3	C.F. Stinson	Symmetry	6	C.F. Stinson	Core	3
C.F. Stinson	On the Money	5	C.F. Stinson	Tangram	5	C.F. Stinson	Criss Cross	4
C.F. Stinson	Oscillate	6	C.F. Stinson	Tessellate	7	C.F. Stinson	Dash	5
C.F. Stinson	Outlander	4	C.F. Stinson	Thicket	4	C.F. Stinson	Diva	5
C.F. Stinson	Pacifica	7	C.F. Stinson	Three60	7	C.F. Stinson	Dodgeball	6
C.F. Stinson	Panorama	6	C.F. Stinson	Tidbit	6	C.F. Stinson	Dynasty	4
C.F. Stinson	Paradox	6	C.F. Stinson	Torus	6	C.F. Stinson	E'Lan-HC	8
C.F. Stinson	Park Avenue	6	C.F. Stinson	Tranquility	6	C.F. Stinson	Effervescence	6
C.F. Stinson	Patriot Plus II	3	C.F. Stinson	Transcend	3	C.F. Stinson	Eli	6
C.F. Stinson	Penelope	5	C.F. Stinson	Tribeca	4	C.F. Stinson	English Pub	4
C.F. Stinson	Peninsula Mohair	9	C.F. Stinson	Trio	6	C.F. Stinson	Entrada	5
C.F. Stinson	Pergola	5	C.F. Stinson	True Path w/ Agion	7	C.F. Stinson	Excursion	3
C.F. Stinson	Perimeter	5	C.F. Stinson	Tweed	6	C.F. Stinson	Expressions	4
C.F. Stinson	Persuasion	5	C.F. Stinson	Twiggy	5	C.F. Stinson	Facet	5
C.F. Stinson	Piccadilly	5	C.F. Stinson	Umbrian Rain	7	C.F. Stinson	Finite	5
C.F. Stinson	Pinball	5	C.F. Stinson	Up Tempo w/ Agion	7	C.F. Stinson	Fizz	5
C.F. Stinson	Pivot	3	C.F. Stinson	Urban Grid	3	C.F. Stinson	Fuse	3
C.F. Stinson	Polka	4	C.F. Stinson	Vanish	7	C.F. Stinson	GeoMet	5
C.F. Stinson	Portico	5	C.F. Stinson	Vapor	7	C.F. Stinson	Glisten	8
C.F. Stinson	Posey	5	C.F. Stinson	Velocity	5	C.F. Stinson	Grand Sierra	4
C.F. Stinson	Posh	5	C.F. Stinson	Vermont	6	C.F. Stinson	Grille	5
C.F. Stinson	Profile	5	C.F. Stinson	Vibe	5	C.F. Stinson	Hashtag	5
C.F. Stinson	Queue	6	C.F. Stinson	View	7	C.F. Stinson	Juxy	6
C.F. Stinson	Radiance	7	C.F. Stinson	Vineyard	7	C.F. Stinson	Kilkenny Tweed	4
C.F. Stinson	Raquette	6	C.F. Stinson	Voltage	7	C.F. Stinson	Kusari	5
C.F. Stinson	Realm	5	C.F. Stinson	Whirl	6	C.F. Stinson	Laredo	3
C.F. Stinson	Retrograde	4	C.F. Stinson	Willow Talk	6	C.F. Stinson	Latitude	3
C.F. Stinson	Revolution	6	C.F. Stinson	Wish	8	C.F. Stinson	Lava	7
C.F. Stinson	Riddle	4	C.F. Stinson	Zoom	5	C.F. Stinson	Liquid	5
C.F. Stinson	Ritz	5						

Graded In Fabrics

Manufacturer	Pattern	Grade	Manufacturer	Pattern	Grade	Manufacturer	Pattern	Grade
C.F. Stinson	Martini	6	C.F. Stinson	Whitney	5	Designtex	Cassava	6
C.F. Stinson	Matrix	5	C.F. Stinson	Wicker	6	Designtex	Catalyst	5
C.F. Stinson	Mesa	8	C.F. Stinson	Wink w/ Agion	6	Designtex	Chapiteau	5
C.F. Stinson	Mica	5	C.F. Stinson	Winnly	5	Designtex	Chromatic	5
C.F. Stinson	Moccasin	3	C.F. Stinson	Wyatt	5	Designtex	Circa	6
C.F. Stinson	Modena	6	C.F. Stinson	Ybor	6	Designtex	Clerkenwell	Call
C.F. Stinson	Montana	4	C.F. Stinson	Ziggy	4	Designtex	Coco	Call
C.F. Stinson	Moxie	6	C.F. Stinson	Zodiac	5	Designtex	Coco Plaid	Call
C.F. Stinson	Natural World	6				Designtex	Code	6
C.F. Stinson	Naugaleather	4				Designtex	Collier	5
C.F. Stinson	Naugasoft	3				Designtex	Colten	5
C.F. Stinson	Neochrome III	4				Designtex	Concept	7
C.F. Stinson	Olympus	6				Designtex	Connor	5
C.F. Stinson	Orbit	5				Designtex	Course	7
C.F. Stinson	Oxford	4				Designtex	Crisscross	7
C.F. Stinson	Patriot Plus II	3				Designtex	Crosshatch	7
C.F. Stinson	Petals	5				Designtex	Crossweave	5
C.F. Stinson	Plexus	6				Designtex	Crosswind	6
C.F. Stinson	Prisma	6				Designtex	Cubitt	7
C.F. Stinson	Raffia	5				Designtex	Current	6
C.F. Stinson	Rainier	4				Designtex	Dart	7
C.F. Stinson	Rally	3				Designtex	Delaine	6
C.F. Stinson	Revolve	7				Designtex	Distressed Texture	6
C.F. Stinson	Rialto	4				Designtex	Divide	7
C.F. Stinson	Ripple	7				Designtex	Dot To Dot	7
C.F. Stinson	Rivera	6				Designtex	Draft	6
C.F. Stinson	Rogue II	3				Designtex	Ellipsis	4
C.F. Stinson	Scout	4				Designtex	Faux Sure	7
C.F. Stinson	Scribe	5				Designtex	Five Cities	7
C.F. Stinson	Script	5				Designtex	Florin	6
C.F. Stinson	Sedona	8				Designtex	Fluent	7
C.F. Stinson	Sentry - HC	4				Designtex	Fomo	5
C.F. Stinson	Shantung	4				Designtex	Forestbound	5
C.F. Stinson	Silverado w/ Agion®	6				Designtex	Fortuna	8
C.F. Stinson	Simplicity	4				Designtex	Friendly Faux	7
C.F. Stinson	Sleek	5				Designtex	Fuse	7
C.F. Stinson	Slightwave	5				Designtex	Gale	6
C.F. Stinson	Smile	6				Designtex	Gamut	4
C.F. Stinson	Smoothie	4				Designtex	Gleam	6
C.F. Stinson	Solitaire	4				Designtex	Gradate	6
C.F. Stinson	Sphere	5				Designtex	Gridley	5
C.F. Stinson	Spirit Millennium	4				Designtex	Halyard	8
C.F. Stinson	Stat-Con	6				Designtex	Hashtag	5
C.F. Stinson	Sterling w/ Agion	6				Designtex	Heather	7
C.F. Stinson	Stitch in Time	4				Designtex	Hem Stitch	5
C.F. Stinson	Sundance w/ StaKleen™	5				Designtex	Henrik Large	8
C.F. Stinson	Symphony Classic	4				Designtex	Henrik Small	8
C.F. Stinson	Tender	8				Designtex	Hexstripe	6
C.F. Stinson	Tendril	4				Designtex	Holmes	8
C.F. Stinson	Tessuto	4				Designtex	Hyde	4
C.F. Stinson	Trax	5				Designtex	Hyphen	6
C.F. Stinson	Valise	3				Designtex	Inertia	7
C.F. Stinson	Vegas	4				Designtex	Inga Large	8
C.F. Stinson	Verdure - EnVi™	5				Designtex	Inga Small	8
C.F. Stinson	Volterra-HC	8				Designtex	Inkling	7
C.F. Stinson	Vortexia	7				Designtex	Inkling	7
C.F. Stinson	Walk the Line	6				Designtex	Inside Edge	6
C.F. Stinson	Waterwand	7				Designtex	Interlock	6
C.F. Stinson	Whisper	3				Designtex	Isotope	6

DESIGNTEX

Manufacturer	Pattern	Grade
Designtex	Acacia	6
Designtex	Adler	5
Designtex	Air	9
Designtex	Alcazar	5
Designtex	Alchemy	5
Designtex	Aloft	5
Designtex	Alpine	5
Designtex	Amwell	Call
Designtex	Angle	8
Designtex	Annex	5
Designtex	Anni	8
Designtex	Appleseed	6
Designtex	Arni	5
Designtex	Array	Call
Designtex	Arthur	Call
Designtex	Aspect	4
Designtex	Aster	8
Designtex	Bark Cloth	6
Designtex	Bead	7
Designtex	Beetled Linen	9
Designtex	Beguiled By The Wild	6
Designtex	Big Dot	6
Designtex	Big Texture	6
Designtex	Billiard Cloth	6
Designtex	Birch Bark Plaid	7
Designtex	Birdseye	3
Designtex	Bitdrift	7
Designtex	Botanique	5
Designtex	Boucle	7
Designtex	Boucle Dot	6
Designtex	Boucle Two-Tone	6
Designtex	Bounce	7
Designtex	Breana	5
Designtex	Brushed Flannel	5
Designtex	Bunta	6
Designtex	Burlap Weave	6
Designtex	Bute Braemar	9
Designtex	Bute Lewis	9
Designtex	Bute Melrose	9
Designtex	Bute Storr	Call
Designtex	Bute Tiree	Call
Designtex	Bute Tweed	9
Designtex	Caiman	5
Designtex	Capsule	7
Designtex	Carrick	9

Manufacturer	Pattern	Grade	Manufacturer	Pattern	Grade	Manufacturer	Pattern	Grade
Designtex	Jaunt	7	Designtex	Rotary	7	Designtex	Woodcut	6
Designtex	Josef	6	Designtex	Rothesay	8	Designtex	Yucca	6
Designtex	Journey	9	Designtex	Round Leaves	8			
Designtex	Kami	8	Designtex	Rove	6			
Designtex	Lambert	8	Designtex	Rumeli	5			
Designtex	Latitude	7	Designtex	Sail	7			
Designtex	Lattice	7	Designtex	Samba	8			
Designtex	Leafette	5	Designtex	Savile Plaid	8			
Designtex	Leap	6	Designtex	Scale	6			
Designtex	Leaves	6	Designtex	Schism	5			
Designtex	Line Variations	7	Designtex	Score	7			
Designtex	Little Dot	6	Designtex	Segment	8			
Designtex	Loop To Loop	8	Designtex	Shibori Stripe	6			
Designtex	Ludington	4	Designtex	Shimmering Tide	9			
Designtex	Luster	6	Designtex	Shortcut	7			
Designtex	Mark	5	Designtex	Silicone Element	7			
Designtex	Measure	5	Designtex	Singing in he Rain	5			
Designtex	Melange	5	Designtex	Sketch	7			
Designtex	Metallo	6	Designtex	Social Dance	7			
Designtex	Metta	5	Designtex	Sorano	5			
Designtex	Microgrid	5	Designtex	Spandau	5			
Designtex	Migration	9	Designtex	Splendor	5			
Designtex	Mingle	7	Designtex	Splice	5			
Designtex	Minnie	4	Designtex	Split	5			
Designtex	Mod	7	Designtex	Sprint	7			
Designtex	Modern Tweed	9	Designtex	Starburst	7			
Designtex	Mohair Plus	Call	Designtex	Strand	6			
Designtex	Motif	6	Designtex	Striae	6			
Designtex	Myddleton	Call	Designtex	Stride	5			
Designtex	Net	7	Designtex	Subtle	5			
Designtex	New Brunswick	3	Designtex	Sunburst	8			
Designtex	Nexus	7	Designtex	Swing	7			
Designtex	Opulent	5	Designtex	Symbol	9			
Designtex	Oscillate	7	Designtex	System	5			
Designtex	Otto	6	Designtex	Tack Cloth	7			
Designtex	Oxford Stripe	7	Designtex	Terra	6			
Designtex	Pause	6	Designtex	Tessellate	9			
Designtex	Pennington	7	Designtex	The Last Aphid	8			
Designtex	Phenomena	7	Designtex	Tiny Herringbone	6			
Designtex	Pigment	8	Designtex	Trace	Call			
Designtex	Pika	5	Designtex	Tramway	7			
Designtex	Pinball	7	Designtex	Treeline	7			
Designtex	Pinpoint	7	Designtex	Triform	6			
Designtex	Pivot	5	Designtex	Trim	7			
Designtex	Pixel	7	Designtex	Trove	5			
Designtex	Plaid	7	Designtex	Tumbleweed	6			
Designtex	Pleat	7	Designtex	Turn	7			
Designtex	Pop Art	7	Designtex	Tweed Multi	5			
Designtex	Posey	7	Designtex	Ulster	3			
Designtex	Prime	5	Designtex	Ulster Upholstery	4			
Designtex	Prompt	7	Designtex	Union Cloth Upholstery	5			
Designtex	Quintessence	7	Designtex	Urban Grid	7			
Designtex	Rail	6	Designtex	Vero	6			
Designtex	Rainwater	7	Designtex	Versed	5			
Designtex	Reppweave	5	Designtex	Vine	7			
Designtex	Revelry	6	Designtex	Vivid	4			
Designtex	Rise	5	Designtex	W	6			
Designtex	Rocket	5	Designtex	Whim	6			
Designtex	Rodenbach	8	Designtex	Windowpane Crypton	6			

GUILFORD OF MAINE		
Manufacturer	Pattern	Grade
Guilford of Maine	Adept	2
Guilford of Maine	Anchorage	2
Guilford of Maine	Aquatint	2
Guilford of Maine	Beacon	2
Guilford of Maine	BeeHave	2
Guilford of Maine	Blink	2
Guilford of Maine	Blinker	2
Guilford of Maine	Cabana Stripe	2
Guilford of Maine	Cadence	2
Guilford of Maine	Clarity	3
Guilford of Maine	Couture	2
Guilford of Maine	Ditty	2
Guilford of Maine	Diva	2
Guilford of Maine	Echo	3
Guilford of Maine	Emphasis	4
Guilford of Maine	Evoke	3
Guilford of Maine	Feedback	4
Guilford of Maine	Flora	2
Guilford of Maine	Frolic	2
Guilford of Maine	George	4
Guilford of Maine	Highbeams	1
Guilford of Maine	Input	2
Guilford of Maine	Instant	3
Guilford of Maine	Intuition	3
Guilford of Maine	Jane	2
Guilford of Maine	Lexicon	3
Guilford of Maine	Liberty (Playful)	2
Guilford of Maine	Lifesaver	2
Guilford of Maine	Limelight	3
Guilford of Maine	Lisbon	3
Guilford of Maine	Mainstream	3
Guilford of Maine	Moguls	3
Guilford of Maine	Moment	2
Guilford of Maine	Open House	1
Guilford of Maine	Oxford	2
Guilford of Maine	Phrase	2
Guilford of Maine	Portofino	3
Guilford of Maine	Quadrille	2
Guilford of Maine	Reason	3
Guilford of Maine	Recharge	3
Guilford of Maine	Relay	3
Guilford of Maine	Revival	4
Guilford of Maine	Rippple	3
Guilford of Maine	Select	3
Guilford of Maine	Showtime	2
Guilford of Maine	Snakeskin	2
Guilford of Maine	Soundbyte	2
Guilford of Maine	Staccato	3
Guilford of Maine	Synopsis	2
Guilford of Maine	Ticker	2
Guilford of Maine	Timeless	2

Graded In Fabrics

Manufacturer	Pattern	Grade
Guilford of Maine	Tracery	2
Guilford of Maine	Transport	2
Guilford of Maine	Underground	2
Guilford of Maine	Whirl	3
Guilford of Maine	Xceed	3

Manufacturer	Pattern	Grade
Knoll	Lore CR	7
Knoll	Mariner	6
Knoll	Melange	9
Knoll	Milestone	7
Knoll	Monarch	6
Knoll	Noble	6
Knoll	Oh La La	5
Knoll	Overture	5
Knoll	Palisade	6
Knoll	Photon II	5
Knoll	Prairie	7
Knoll	Presto	5
Knoll	Pullman	6
Knoll	Radiance	7
Knoll	Ransom	6
Knoll	Rebel	7
Knoll	Relay	6
Knoll	Repertoire	6
Knoll	Sahara	7
Knoll	Sashiko	6
Knoll	Sequin CR	7
Knoll	Smart	7
Knoll	Soliloquy	5
Knoll	Sonnet	5
Knoll	Spark	6
Knoll	Summit	5
Knoll	Swank	9
Knoll	Swing	8
Knoll	Synth	5
Knoll	Tailor Made II	5
Knoll	Tinge	5
Knoll	Tivoli	9
Knoll	Totem	9
Knoll	Trophy	5
Knoll	Tryst	9
Knoll	Ultrasuede	Call
Knoll	Uni-Form	5
Knoll	Utmost	7
Knoll	Venue	5
Knoll	Westwood	5
Knoll	Whip	7
Knoll	Wide Angle	8

Manufacturer	Pattern	Grade
Luna	Boutique	7
Luna	Broome	8
Luna	Bungalow	7
Luna	Burst	7
Luna	Charm	Call
Luna	Cloud	8
Luna	Dapple	7
Luna	Delight	6
Luna	Dish	5
Luna	Doodad	8
Luna	Dots Damask	7
Luna	Downtown Two	5
Luna	Enchant	9
Luna	Endless	8
Luna	Ensemble	Call
Luna	Esperanto	8
Luna	Facet	7
Luna	Filament	8
Luna	Flare	8
Luna	Flash	7
Luna	Framework	6
Luna	Freehand	5
Luna	Gizmo	8
Luna	Halo	5
Luna	Hammered Metal	5
Luna	Hardcopy	5
Luna	Hardware	8
Luna	Harmonize	5
Luna	Hatch	8
Luna	Hatch Too	5
Luna	HiFi	5
Luna	Highlight	6
Luna	Hush	6
Luna	Idyll	5
Luna	Incandescent	5
Luna	Intersect	5
Luna	Jaunty	6
Luna	Linea	4
Luna	Linen	7
Luna	Loop	8
Luna	Luna Atelier 01 (LA01)	8
Luna	Matchsticks	6
Luna	Mezzanine	6
Luna	Micro Bubbly	9
Luna	Mobile	7
Luna	Motif.	7
Luna	Nifty	4
Luna	Notion	5
Luna	Peek	8
Luna	Plaza	6
Luna	Propeller	9
Luna	Quad	5
Luna	Radar	5
Luna	Redfern	Call
Luna	Redondo	8
Luna	Signal	5
Luna	Sketch Stripe	9
Luna	Snug	Call
Luna	Sonic	5

KNOLL

Manufacturer	Pattern	Grade
Knoll	Aegean	7
Knoll	Atelier	9
Knoll	Atlas	7
Knoll	Basket Draft	5
Knoll	Beacon	3
Knoll	Bollywood	6
Knoll	Boundary	5
Knoll	Calypso	5
Knoll	Cameo	7
Knoll	Chain Link	6
Knoll	Chroma	7
Knoll	Circa	8
Knoll	Classic Boucle	8
Knoll	Close Knit	7
Knoll	Coco	Call
Knoll	Color Field	5
Knoll	Common Ground	6
Knoll	Commuter Cloth	6
Knoll	Crossroad	5
Knoll	Day Tripper	5
Knoll	Delite	3
Knoll	Diva	5
Knoll	Djenne	9
Knoll	Dristi	6
Knoll	Dune	5
Knoll	Entourage	7
Knoll	Ferry	5
Knoll	Foil Rap	6
Knoll	Forza	7
Knoll	Gezelle	Call
Knoll	Groovy	6
Knoll	Hard Rock	6
Knoll	Harrison	9
Knoll	Hastings	Call
Knoll	Haze	9
Knoll	Heavy Metal	6
Knoll	Helios	5
Knoll	Highland	8
Knoll	Hourglass	5
Knoll	Instinct	5
Knoll	Journey	5
Knoll	Juno	7
Knoll	Kampala	8
Knoll	Kaya CR	6
Knoll	Keaton	5
Knoll	Kingston	9
Knoll	Liberty	9
Knoll	Little Devil	4

LUNA

Manufacturer	Pattern	Grade
Luna	Acolyte	8
Luna	Affinity	7
Luna	Alexander	5
Luna	Allegra	8
Luna	Allure	Call
Luna	Amuse	7
Luna	Beam	8
Luna	Betwixt	6
Luna	Boink	7
Luna	Boomerang	8
Luna	Boucle Stripe	7

Manufacturer	Pattern	Grade
Luna	Boutique	7
Luna	Broome	8
Luna	Bungalow	7
Luna	Burst	7
Luna	Charm	Call
Luna	Cloud	8
Luna	Dapple	7
Luna	Delight	6
Luna	Dish	5
Luna	Doodad	8
Luna	Dots Damask	7
Luna	Downtown Two	5
Luna	Enchant	9
Luna	Endless	8
Luna	Ensemble	Call
Luna	Esperanto	8
Luna	Facet	7
Luna	Filament	8
Luna	Flare	8
Luna	Flash	7
Luna	Framework	6
Luna	Freehand	5
Luna	Gizmo	8
Luna	Halo	5
Luna	Hammered Metal	5
Luna	Hardcopy	5
Luna	Hardware	8
Luna	Harmonize	5
Luna	Hatch	8
Luna	Hatch Too	5
Luna	HiFi	5
Luna	Highlight	6
Luna	Hush	6
Luna	Idyll	5
Luna	Incandescent	5
Luna	Intersect	5
Luna	Jaunty	6
Luna	Linea	4
Luna	Linen	7
Luna	Loop	8
Luna	Luna Atelier 01 (LA01)	8
Luna	Matchsticks	6
Luna	Mezzanine	6
Luna	Micro Bubbly	9
Luna	Mobile	7
Luna	Motif.	7
Luna	Nifty	4
Luna	Notion	5
Luna	Peek	8
Luna	Plaza	6
Luna	Propeller	9
Luna	Quad	5
Luna	Radar	5
Luna	Redfern	Call
Luna	Redondo	8
Luna	Signal	5
Luna	Sketch Stripe	9
Luna	Snug	Call
Luna	Sonic	5

Manufacturer	Pattern	Grade
Luna	Sparkle	5
Luna	Spellbound	9
Luna	Splice	5
Luna	Staccato	8
Luna	Stacking Chairs	8
Luna	Stars	6
Luna	Stepping Stones	5
Luna	Stitch	5
Luna	Switchback	6
Luna	Tech Stripe	8
Luna	Tech Twist	6
Luna	Telepathy	7
Luna	Transmission	5
Luna	Trapeze	4
Luna	Twiggy	8
Luna	Twist	5
Luna	Urban Grid	8
Luna	Waffle	5
Luna	Wallflower	5
Luna	Whimsy	6
Luna	Wish	6

Manufacturer	Pattern	Grade
Luum	Stimuli	5
Luum	Subdivide	6
Luum	Substance	6
Luum	Synaptic	6
Luum	Thangka	7
Luum	Two Tone	7
Luum	Ultra Durable	5
Luum	Velvet Underground	6
Luum	Vital	7

Manufacturer	Pattern	Grade
Maharam	Divide Crypton	6
Maharam	Emit	5
Maharam	Emesh	5
Maharam	Exchange	5
Maharam	Fasten	7
Maharam	Fathom	5
Maharam	Feature	6
Maharam	Floret	6
Maharam	Fluent Cryton	6
Maharam	Focus	5
Maharam	Fraction	6
Maharam	Furrow	6
Maharam	Gild	6
Maharam	Grade	7
Maharam	Grove	6
Maharam	Hedge	6
Maharam	Helix	7
Maharam	Insignia	7
Maharam	Instill	5
Maharam	Joist	8
Maharam	Keen	5
Maharam	Kindred	6
Maharam	Knob	Call
Maharam	Knot	9
Maharam	Lariat	5
Maharam	Latch	7
Maharam	Ledger	5
Maharam	Lens	5
Maharam	Limn	8
Maharam	Lineage	5
Maharam	Lunar	5
Maharam	Marquee	5
Maharam	Medium	5
Maharam	Medley	5
Maharam	Meridian	6
Maharam	Merit	5
Maharam	Messenger	5
Maharam	Metric	5
Maharam	Micro	5
Maharam	Milestone	5
Maharam	Mineral	6
Maharam	Multiply	5
Maharam	Murmur	5
Maharam	Oblique	5
Maharam	Offset	7
Maharam	Omen	6
Maharam	Orbit	5
Maharam	Parquet	7
Maharam	Pennant	6
Maharam	Pick	5
Maharam	Pick Crypton	6
Maharam	Plait	5
Maharam	Pocket	6
Maharam	Prime	6
Maharam	Quay	6
Maharam	Quick	5
Maharam	Radiant	8
Maharam	Reel	7
Maharam	Runner	6

MAHARAM

Manufacturer	Pattern	Grade
Maharam	Abacus	6
Maharam	Abacus Standard	5
Maharam	Across	6
Maharam	Akimbo	6
Maharam	Alloy	6
Maharam	Alter	6
Maharam	Anagram	7
Maharam	Apt	7
Maharam	Array	6
Maharam	Article	5
Maharam	Banister	6
Maharam	Bar	5
Maharam	Bar Crypton	6
Maharam	Beam	7
Maharam	Beside	6
Maharam	Bevel	5
Maharam	Bitmap	5
Maharam	Blip	7
Maharam	Brio	6
Maharam	Candid	5
Maharam	Caper	5
Maharam	Cartouche	6
Maharam	Centric	7
Maharam	Chance	6
Maharam	Chasm	6
Maharam	Chime	5
Maharam	Chock	6
Maharam	Circuit	6
Maharam	Clamber	6
Maharam	Coin	5
Maharam	Coincide	5
Maharam	Column	6
Maharam	Compound	6
Maharam	Conduit	5
Maharam	Crew	6
Maharam	Crush	6
Maharam	Dapper	5
Maharam	Dart	6
Maharam	Decode	6
Maharam	Disc	5
Maharam	Disc Crypton	6
Maharam	Disperse	6
Maharam	Ditto	7
Maharam	Divide	5

LUUM

Manufacturer	Pattern	Grade
Luum	Amalgam	6
Luum	Ample	5
Luum	Angulo	8
Luum	Beaded Stripe	5
Luum	Complement	5
Luum	Cross Dye	5
Luum	Disrupt	7
Luum	Filar	5
Luum	Fine Grain	5
Luum	Flexagon	6
Luum	Full Wool	8
Luum	Fundamentals	3
Luum	Ghat	7
Luum	Heather Felt	7
Luum	Homage	7
Luum	Implex	5
Luum	Intone	5
Luum	Iterate	8
Luum	Knurl	6
Luum	Line Language	7
Luum	Magnify	4
Luum	Marl Cloth	5
Luum	Miami	5
Luum	Monotex	6
Luum	Navigate	Call
Luum	Outpress	7
Luum	Percept	5
Luum	Perilune	6
Luum	Point Emboss	5
Luum	Point to Point	7
Luum	Refraction	6
Luum	Situ	5

Graded In Fabrics

Manufacturer	Pattern	Grade	Manufacturer	Pattern	Grade	Manufacturer	Pattern	Grade
Maharam	Runner Standard	5	Mayer	Aspect	5	Mayer	Dublin Tweed FR	4
Maharam	Salon	9	Mayer	Atomic	3	Mayer	Durango	3
Maharam	Scape	7	Mayer	Aurora	6	Mayer	Duraweave® 10	1
Maharam	Schema	6	Mayer	Avenue	5	Mayer	Echo	4
Maharam	Scuba	6	Mayer	Awakening	4	Mayer	Ecosphere	5
Maharam	Scute	5	Mayer	Banner	3	Mayer	Eleanor Rigby	5
Maharam	Scuttle	6	Mayer	Bar None	2	Mayer	Element	3
Maharam	Seam	5	Mayer	Basic	1	Mayer	Elevation	5
Maharam	Serif	7	Mayer	Batik	3	Mayer	Entourage	6
Maharam	Serried	7	Mayer	Beckon	2	Mayer	Entwine	4
Maharam	Sheen	6	Mayer	Bella	2	Mayer	Ephesus	5
Maharam	Slant	6	Mayer	Berkshire	5	Mayer	Equal	2
Maharam	Sort	5	Mayer	Big Top	5	Mayer	Equation	4
Maharam	Span	6	Mayer	Blocks	3	Mayer	Equinox	4
Maharam	Stature	5	Mayer	Bolero	5	Mayer	Erode	6
Maharam	Steady	5	Mayer	Botanica	5	Mayer	Escapade	5
Maharam	Steady Crypton	6	Mayer	Boteh	7	Mayer	Esprit	4
Maharam	Stride	6	Mayer	Brio	5	Mayer	Essence	5
Maharam	Strum	6	Mayer	Burst	5	Mayer	Essex	4
Maharam	Sudden	6	Mayer	Camelot	4	Mayer	Europa	4
Maharam	Surge	6	Mayer	Canvas	5	Mayer	Evolve	6
Maharam	Tailor	5	Mayer	Caressa FR	3	Mayer	Facets	6
Maharam	Tempera	6	Mayer	Caressa Suede	4	Mayer	Fairy Tales	6
Maharam	Tend	6	Mayer	Cascade	5	Mayer	FanFare	6
Maharam	Ticker	6	Mayer	Catwalk	4	Mayer	Fedora	3
Maharam	Tilt	6	Mayer	Cavalier	3	Mayer	Figure Eight	3
Maharam	Trait	6	Mayer	Cayman	5	Mayer	Finale	5
Maharam	Treat	6	Mayer	Celtic	5	Mayer	Finesse	3
Maharam	Trio	8	Mayer	Chaps FR	4	Mayer	Flock	6
Maharam	Trundle	5	Mayer	Charade	5	Mayer	Florentino	3
Maharam	Urban	6	Mayer	Charette	3	Mayer	Flower Power	3
Maharam	Venn	6	Mayer	Chequers	5	Mayer	Focal Point	3
Maharam	Wedge	6	Mayer	Circuit	6	Mayer	Forté	1
Maharam	Wend	5	Mayer	Circumference	6	Mayer	Foundation 10	2
Maharam	Whirl	5	Mayer	Cirque	4	Mayer	Fresco	2
Maharam	Wrap	5	Mayer	Collage	6	Mayer	Fretwork	6
			Mayer	Comalapa	6	Mayer	Gala	5
			Mayer	Component	3	Mayer	Geisha	7
			Mayer	Contempo	3	Mayer	Genesis	3
			Mayer	Continuum	3	Mayer	Genesis plus NanoGuard™	5
			Mayer	Convergence	4	Mayer	Glimmer	5
			Mayer	Copa	2	Mayer	Grasscloth	2
			Mayer	Cork	5	Mayer	Groundworks	5
			Mayer	Cosmopolitan	4	Mayer	Guardian	3
			Mayer	Counterpoint	5	Mayer	Haarlem	6
			Mayer	Cross Check	1	Mayer	Haberdash	3
			Mayer	Cuddle Up	5	Mayer	Habitat	5
			Mayer	Curlicue	3	Mayer	Hexagon	4
			Mayer	Dakota	4	Mayer	Holiday	5
			Mayer	Dande	4	Mayer	Hombre	5
			Mayer	Dapper	3	Mayer	Honeycomb	2
			Mayer	Daydream	5	Mayer	Hoopla	3
			Mayer	Dazzle	5	Mayer	Huipil	6
			Mayer	Debonair	5	Mayer	Illusion	3
			Mayer	Debut	6	Mayer	Images	3
			Mayer	Destiny	3	Mayer	Imprint	3
			Mayer	Destiny plus NanoGuard™	5	Mayer	Impulse	1
			Mayer	Detail	5	Mayer	In The Groove	4
			Mayer	Disco	5	Mayer	Infinity	5

MAYER

Manufacturer	Pattern	Grade
Mayer	Abbey	5
Mayer	Acclaim	5
Mayer	Acuco	6
Mayer	Align	3
Mayer	All Seasons FR	3
Mayer	All Use FR	2
Mayer	Amadeus	5
Mayer	Anasazi	3
Mayer	Ankara	5
Mayer	Antique	4
Mayer	Apex	3
Mayer	Apollo Silicone	6
Mayer	Arabesque	5
Mayer	Aristocrat	5
Mayer	Array	5
Mayer	Artistry	3
Mayer	Ascension	6

Manufacturer	Pattern	Grade	Manufacturer	Pattern	Grade	Manufacturer	Pattern	Grade
Mayer	Interlace	4	Mayer	Obi	6	Mayer	Sketch	4
Mayer	Interlochen	4	Mayer	Obsession	6	Mayer	Slick	4
Mayer	Interlude	2	Mayer	Odessa	5	Mayer	Smart Suede	5
Mayer	Intrigue	4	Mayer	On the Spot	5	Mayer	Social Network	5
Mayer	Jekyll & Hyde	4	Mayer	Optic	3	Mayer	Soho	5
Mayer	Jenga	4	Mayer	Orbit	4	Mayer	Soleil	6
Mayer	Jitterbug	5	Mayer	Origami	6	Mayer	Sophisticate	4
Mayer	Journey	5	Mayer	Outback	3	Mayer	Source	4
Mayer	Jubilee	3	Mayer	Oxen SP Black	1	Mayer	Source plus NanoGuard™	5
Mayer	Juncture	7	Mayer	Palermo	5	Mayer	Space Odyssey	3
Mayer	Karma	5	Mayer	Paparazzi	6	Mayer	Spacer Mesh	2
Mayer	Katagami	6	Mayer	Paradigm	4	Mayer	Spectre	3
Mayer	Kensington	5	Mayer	Paragon	3	Mayer	Splendor	5
Mayer	Key Largo	3	Mayer	Pastime	5	Mayer	Spokes	6
Mayer	Kismet	5	Mayer	Patent	5	Mayer	Strata	2
Mayer	Kobe	3	Mayer	Patio	3	Mayer	Suede	5
Mayer	Laredo	5	Mayer	Pebble Beach	2	Mayer	Sula	7
Mayer	Latitude	5	Mayer	Peerless	4	Mayer	Suna	6
Mayer	Lavish	4	Mayer	Phoenix	4	Mayer	Sutra	6
Mayer	Linen	3	Mayer	Pinehurst	4	Mayer	Synapse	6
Mayer	Links	4	Mayer	Pinnacle	3	Mayer	Tangram	7
Mayer	Locomotion	3	Mayer	Plaza	5	Mayer	Tattersall	5
Mayer	London	5	Mayer	Polygon	4	Mayer	Tea Leaves	2
Mayer	Longhorn	5	Mayer	Portal	4	Mayer	Terrain	3
Mayer	Longitude	5	Mayer	Positive Thoughts	6	Mayer	Textura	6
Mayer	Lotus	6	Mayer	Prado	4	Mayer	Theory	3
Mayer	Luminary	2	Mayer	Primo	5	Mayer	Time Line	5
Mayer	Lunar	1	Mayer	Prism	3	Mayer	Toss Up	4
Mayer	Madras	4	Mayer	Punch	3	Mayer	Tributary	4
Mayer	Madrid SP Black	1	Mayer	Puno	6	Mayer	Turnabout	6
Mayer	Makore	5	Mayer	Quattro	2	Mayer	Tussah	4
Mayer	Malibu	5	Mayer	Rain Dance	5	Mayer	Twister	4
Mayer	Mandala	7	Mayer	Ranchero	1	Mayer	Uptown	4
Mayer	Matka	4	Mayer	Razzmatazz	6	Mayer	Valet	3
Mayer	Matrix	6	Mayer	Reflector	6	Mayer	Variant	3
Mayer	Maverick	3	Mayer	Rejuvenate	6	Mayer	Venetian	8
Mayer	Mayfair	5	Mayer	Replay	5	Mayer	Venue	4
Mayer	Meander	3	Mayer	Reveal	5	Mayer	Verona	4
Mayer	Melange	3	Mayer	Reverb	3	Mayer	Vibrant	5
Mayer	Metal Strips	6	Mayer	Rhythm	6	Mayer	Viewpoint	6
Mayer	Microdot	3	Mayer	Rift	5	Mayer	Vintage Mohair	Call
Mayer	Milagro	6	Mayer	Ritz	1	Mayer	Vinyl Stat ESD	5
Mayer	Milano	4	Mayer	Rock & Roll	5	Mayer	Vipassana	6
Mayer	Mingle	4	Mayer	Round 'N Round	6	Mayer	Vogue	4
Mayer	Mode	5	Mayer	Sakura	6	Mayer	Volante	8
Mayer	Monogram	4	Mayer	Samurai	6	Mayer	Wallaby SP Black	1
Mayer	Moonscape	3	Mayer	Sashiko	6	Mayer	Webscape	3
Mayer	Morse	5	Mayer	Score		Mayer	Whimsy	6
Mayer	Mosaic	3	Mayer	Sequel	2	Mayer	Whirligig	6
Mayer	Mosaic plus NanoGuard™	5	Mayer	Sequel plus NanoGuard™	4	Mayer	Whirlwind	2
Mayer	Multi-Crepe	2	Mayer	Sequence	4	Mayer	Wildflower	6
Mayer	Neo	5	Mayer	Shantung	3	Mayer	Willow	3
Mayer	New Dimensions	6	Mayer	Sherlock	3	Mayer	Wilson	6
Mayer	Nexus	2	Mayer	Shibori	6	Mayer	Wool Boucle	7
Mayer	Niche	5	Mayer	Shimmer	5	Mayer	Xanadu	6
Mayer	Nirvana	6	Mayer	Sierra SP Black	1	Mayer	Zazen	6
Mayer	Noble	3	Mayer	Signs	6	Mayer	Zen	6
Mayer	Nostalgia	5	Mayer	Silk Screen	4	Mayer	Zest	2
Mayer	Nylon-Stat ESD	5	Mayer	SilverWeave	4			

Graded In Fabrics

MOMENTUM

Manufacturer	Pattern	Grade
Momentum	3D Grid	9
Momentum	Ace	4
Momentum	Acoustic	7
Momentum	Agora II	5
Momentum	Aldo	9
Momentum	Allegory	8
Momentum	Amentiy II	7
Momentum	Amuse	5
Momentum	April	6
Momentum	Archer	7
Momentum	Arrange	8
Momentum	Audubon	8
Momentum	Bandwidth II	7
Momentum	Bangle	4
Momentum	Banter	8
Momentum	Beeline EPU	5
Momentum	Beep	5
Momentum	Bloc	8
Momentum	Bobby	4
Momentum	Boom II	5
Momentum	Boxcar	7
Momentum	Bravo II	6
Momentum	Brisk	7
Momentum	Buoy	7
Momentum	Canter EPU	5
Momentum	Cairns	8
Momentum	Camber	8
Momentum	Carlo	9
Momentum	Cashmere II	5
Momentum	Centric	7
Momentum	Chipper	8
Momentum	Chromatic	7
Momentum	Cityscape	8
Momentum	Clang	5
Momentum	Colorwheel	7
Momentum	Course	7
Momentum	Cover CLoth	5
Momentum	Croquet	7
Momentum	Crossing Colors	9
Momentum	Cycle	6
Momentum	Cryptic	7
Momentum	Cube	7
Momentum	Current	5
Momentum	Cutout	9
Momentum	Dart	5
Momentum	Dash	7
Momentum	Dayspell	7
Momentum	Decode	5
Momentum	Delve	6
Momentum	Dive	6
Momentum	Drawing Lines	8
Momentum	Drift	7
Momentum	Ebb	8
Momentum	Echo II	7
Momentum	Edison	7
Momentum	Embark	6
Momentum	Endurance EPU	5
Momentum	Eon EPU	5

Manufacturer	Pattern	Grade
Momentum	Epic	4
Momentum	Essay	7
Momentum	Estrella	8
Momentum	Explore	8
Momentum	Expo	4
Momentum	Faux Felt	5
Momentum	Fleet	6
Momentum	Float	5
Momentum	Flow	7
Momentum	Flux	8
Momentum	Focal	5
Momentum	Fold	8
Momentum	Foray	6
Momentum	Free	5
Momentum	Fuse	4
Momentum	Geo	8
Momentum	Glide	6
Momentum	Graph	5
Momentum	Grid	4
Momentum	Groove EPU	5
Momentum	Guild	4
Momentum	Habit	5
Momentum	Halo	7
Momentum	Hearsay	7
Momentum	Helm	7
Momentum	Hive	6
Momentum	Hop	6
Momentum	Hue	5
Momentum	Icon	7
Momentum	Infinity	5
Momentum	Insight	4
Momentum	Interim	8
Momentum	Interlock	9
Momentum	Intermix II	5
Momentum	Jitney	7
Momentum	Jot	5
Momentum	Journal	8
Momentum	Kindle	6
Momentum	Kindred	7
Momentum	Kinney	5
Momentum	Knack	5
Momentum	Ledge	5
Momentum	Lella	8
Momentum	Lens	5
Momentum	Leno	7
Momentum	Level	7
Momentum	Lina	8
Momentum	Lineup	5
Momentum	Llyod	9
Momentum	Lore	7
Momentum	Lucio	Call
Momentum	Ludwig	9
Momentum	Malmo	8
Momentum	Mapping Ideas	8
Momentum	Marathon	5
Momentum	Marcel	8
Momentum	Memory	8
Momentum	Millennium	5
Momentum	Mix	8

Manufacturer	Pattern	Grade
Momentum	Nagoya	8
Momentum	Nifty	5
Momentum	Nimble	8
Momentum	Odyssey	5
Momentum	Ohs II	8
Momentum	Origin	4
Momentum	Painting Strokes	8
Momentum	Panorama	8
Momentum	Parable	7
Momentum	Parentesi	9
Momentum	Paenthesis	4
Momentum	Perk	4
Momentum	Phonton	7
Momentum	Phrase	7
Momentum	Pierre	9
Momentum	Ping	5
Momentum	Pique	5
Momentum	Places Spaces Faces	9
Momentum	Propel	7
Momentum	Propensity II	5
Momentum	Prospect	6
Momentum	Proximity	8
Momentum	Pursue	7
Momentum	Quince	8
Momentum	Rally	7
Momentum	Refract	7
Momentum	Rein II	5
Momentum	Reveal	8
Momentum	Revolve	8
Momentum	Riga	8
Momentum	Ring	7
Momentum	Rise	5
Momentum	Rivet	5
Momentum	Row	5
Momentum	Rubato	7
Momentum	Rush Hour	8
Momentum	Sail	7
Momentum	Scan	8
Momentum	Scrabble	5
Momentum	Sidestep	7
Momentum	Silica	7
Momentum	Silica Leather	7
Momentum	Site Line	1
Momentum	Sketching Air	8
Momentum	Skip	5
Momentum	Slice	5
Momentum	Small Talk	7
Momentum	Solace	5
Momentum	Sort	7
Momentum	Spontaneous	8
Momentum	Starbound	7
Momentum	Story	7
Momentum	Stroll	5
Momentum	Strut	5
Momentum	Sublime II	6
Momentum	Symbol	8
Momentum	Syntax	5
Momentum	Tact II	7
Momentum	Tactic	8

Manufacturer	Pattern	Grade
Momentum	Tech Waeve	Call
Momentum	Tesla	7
Momentum	Tetra	5
Momentum	Tilt	6
Momentum	Toggle	4
Momentum	Traction	8
Momentum	Tradition	5
Momentum	Trapeze	7
Momentum	Trivia	7
Momentum	Trove	8
Momentum	Turin	8
Momentum	Twist	8
Momentum	Uplift	7
Momentum	Veer	6
Momentum	Velocity	5
Momentum	Via	5
Momentum	Vox	4
Momentum	Wander	7
Momentum	Weaing Palettes	7
Momentum	Well Well Well	9
Momentum	Whim	7
Momentum	Whit EPU	5
Momentum	Why Why Why	9
Momentum	Zipped	7

PAUL BRAYTON

Manufacturer	Pattern	Grade
Paul Brayton	Al Fresco	6
Paul Brayton	Alpine	7
Paul Brayton	Angus	6
Paul Brayton	Avery	5
Paul Brayton	Backgammon	7
Paul Brayton	Canopy	6
Paul Brayton	Cirrus	6
Paul Brayton	Divine	4
Paul Brayton	Flannelsuede - 3100	8
Paul Brayton	Flannelsuede - 3103	8
Paul Brayton	Frolic	6
Paul Brayton	Fun	6
Paul Brayton	Jilly Twill	4
Paul Brayton	Journey	6
Paul Brayton	Killian	6
Paul Brayton	Meridian	5
Paul Brayton	Molly	6
Paul Brayton	Moonstruck	7
Paul Brayton	Nimbus	6
Paul Brayton	Odyssey	7
Paul Brayton	Pizzelle	6
Paul Brayton	Prizm	7
Paul Brayton	Promenade	6
Paul Brayton	Quest	6
Paul Brayton	Rhyme	4
Paul Brayton	Somerfield	6
Paul Brayton	Spinnaker	7
Paul Brayton	Stratus	6
Paul Brayton	Textura HG Almost	7

Manufacturer	Pattern	Grade
Paul Brayton	Toto Plaid	6
Paul Brayton	Tulip	6
Paul Brayton	Woodland	7

ULTRAFABRICS

Manufacturer	Pattern	Grade
Ultrafabrics	Brisa	5
Ultrafabrics	Brisa Indoor/Outdoor	5
Ultrafabrics	Brisa Distressed	5
Ultrafabrics	Brisa Distressed Indoor/Outdoor	5
Ultrafabrics	Brisa Fresco	5
Ultrafabrics	Brisa Mokume	5
Ultrafabrics	Cora	5
Ultrafabrics	Cove	5
Ultrafabrics	Dwell	5
Ultrafabrics	Eco Tech	5
Ultrafabrics	Fusion	5
Ultrafabrics	Fusion Shimmer	5
Ultrafabrics	Helix	5
Ultrafabrics	Linen	5
Ultrafabrics	Pony	5
Ultrafabrics	Primera	3
Ultrafabrics	Promessa	5
Ultrafabrics	Promessa Indoor/Outdoor	5
Ultrafabrics	Strada	4
Ultrafabrics	Toscana	4
Ultrafabrics	Uccello	5
Ultrafabrics	Ultraleather	5
Ultrafabrics	Ultraleather Pearlized	5
Ultrafabrics	Ultraleather Pro	5
Ultrafabrics	Ultraleather Tottori	5
Ultrafabrics	Ultratech Wired	5
Ultrafabrics	Viva	5

CTL LEATHER

Manufacturer	Pattern	Grade
CTL Leather	Atlantic	Call
CTL Leather	Barolo	Call
CTL Leather	Bull Soft	Call
CTL Leather	Capri	Call
CTL Leather	Caress	Call
CTL Leather	Classico	Call
CTL Leather	Cowboy	Call
CTL Leather	Dakota	Call
CTL Leather	Dallas Soft	Call
CTL Leather	Dublin	Call
CTL Leather	Elegance	Call
CTL Leather	Epic	Call
CTL Leather	Heritage	Call
CTL Leather	Linea	Call
CTL Leather	Lodge	Call
CTL Leather	Madras	9
CTL Leather	Mardi Gras	Call
CTL Leather	Mustang	Call
CTL Leather	Palma	Call
CTL Leather	Paradiso	Call
CTL Leather	Prescott	Call
CTL Leather	Queensland	Call
CTL Leather	Rio	Call
CTL Leather	Roxy	Call
CTL Leather	Santiago	Call
CTL Leather	Seide	Call
CTL Leather	Siena	Call
CTL Leather	Stagecoach	Call
CTL Leather	Tuscania	Call
CTL Leather	Valencia	Call
CTL Leather	Vogue	Call

NeutralPosture

Visit NeutralPosture.com or call 979.778.0502

BIFMA e3/LEVEL
GSA

WOMEN[™]
OWNED

ISO 9001:2015 Approved
SCS Indoor Advantage